



MOTORTRONICS™

Solid State AC Motor Control

DXT

Series

Advanced Digital Soft Starter

Ratings 39 - 1250A

INSTALLATION & OPERATION MANUAL

Table of Contents

	PAGE
Chapter 1: Introduction	4-11
1.1 Overview	4
1.2 Specifications	4-6
1.3 Reference Chart	7
1.4 Theory of Operation	8
1.5 General Protection	9
1.6 Thermal Overload Protection	10-11
Chapter 2: Installation	12-19
2.1 Receiving and Unpacking	12
2.2 Initial Unit Inspection	12
2.3 Location	12
2.4 Mounting and Cleaning	12
2.5 Power Terminal Wire Range and Tightening Torque	12
2.6 Dimensions	13
2.7 Power Connections	14
2.8 Control Connections	14-15
2.9 Reference Section	16
2.9a Optional RTD Board	16
2.9b Power Board	17
2.9c CPU Board	18
2.9d Communication Board	19
Chapter 3: Start-Up	20-23
3.1 Preliminary Start-Up Check List	20
3.2 Introduction	20
3.3 Acceleration Adjustments	20
3.4 Deceleration Adjustments	21-22
3.5 Sequence of Normal Operation	23
Chapter 4: User Interface and Menu Navigation	24-26
4.1 Keypad / Operator Interface	24
4.1.1 Keypad Operator designations and functions	25
4.2 Menu Navigation	25
4.2.1 Password Access	26
4.2.2 Changing Setpoints	26
Chapter 5: Setpoint Programming	27-62
5.1 Setpoints Page List	27-33
5.1.1 Basic Configuration (Setpoint Page 1)	27
5.1.2 Starter Configuration (Setpoint Page 2)	27
5.1.3 Phase and Ground Settings (Setpoint Page 3)	28
5.1.4 Relay Assignments (Setpoint Page 4)	29
5.1.5 Relay Configuration (Setpoint Page 5)	30
5.1.6 User I/O Configuration (Setpoint Page 6)	30
5.1.7 Custom Acceleration Curve (Setpoint Page 7)	31
5.1.8 Overload Curve Configuration (Setpoint Page 8)	31

Table of Contents - Continued

	PAGE
5.1.9 RTD Option Configuration (Setpoint Page 9)	32
5.1.10 Password Level Configuration (Setpoint Page 10)	33
5.1.11 Communication (Setpoint Page 11)	33
5.1.12 System (Setpoint Page 12)	33
5.1.13 Calibration and Service (Setpoint Page 13)	33
 5.2 Setpoints Menu and Parameter Explanation	 34-61
SP.1 Basic Configuration.....	34-35
SP.2 Starter Configuration.....	36-40
Fig. SP2.3 Example of Switching from Jog to Start Ramp #1 Type: Voltage	37
Fig. SP2.4 Power Ramp.....	39
SP.3 Phase & Ground Settings	41-43
Fig. SP3.5 Overcurrent Trip Delay Graph.....	41
SP.4 Relay Assignment.....	44-45
SP.5 Relay Configuration	46
SP.6 User I/O Configuration	47-50
SP.7 Custom Acceleration Curve	51-53
SP.8 Overload Curve Configuration	54-55
SP.9 RTD Option Configuration	56-57
SP.10 Set Password.....	58
SP.11 Communications	58
SP.12 System Setpoints.....	59-60
SP.13 Calibration & Service	61
 Chapter 6: Metering Pages	 62-72
6.1 Metering Page List.....	62
6.1.1 Metering Menu & Data (Metering Page 1)	62
6.1.2 Metering (Metering Page 2)	62
6.1.3 RTD Option Values (Metering Page 3)	62
6.1.4 Status (Metering Page 4)	63
6.1.5 Event Recorder (Metering Page 5)	63
6.1.6 Last Trip (Metering Page 6)	63
6.1.7 Statistics (Metering Page 7)	64
 6.2 Metering Menu and Explanation.....	 65
MP.1 Metering Data.....	66
MP.2 Metering	67
MP.3 RTD Values	68
MP.4 Status	69
MP.5 Event Recorder – 60 Events	70
MP.6 Last Trip	71
MP.7 Statistics	72
 Chapter 7: Maintenance and Troubleshooting	 73-81
7.1 Failure Analysis	73-75
7.2 SCR Testing Procedure.....	76
7.3 Replacing SCR Devices	77-78
7.4 Replacing the Main Control Board.....	79
7.5 Interconnect Drawing.....	80-81

Chapter 1 - Introduction

This chapter is a brief introduction to the **DXT Series** Soft Starter and describes product operation and unit features.

1.1 Overview

The **DXT Series** is a high-end digitally programmable solid state reduced voltage motor starter. This heavy duty starter provides reduced voltage, step less soft starting of 3- phase AC induction motors. It protects mechanical components from damaging torque stress and electrical systems from the effects of high motor inrush currents. The **DXT Series** includes advanced motor and load protection features just like those found in expensive motor protection relays. These include retentive thermal memory, dynamic reset capacity, true thermal modeling, separate trip curves for start and run protection, overload alarm, etc. But in the case of the **DXT Series**, these features were built in as standard, providing a cost effective and reliable motor starting and protection scheme for your critical motor applications.

The **DXT Series** features an easy to use keypad operator interface for programming and status indication. It includes a large tactile feedback keypad, LED status indicators and a 2 line x 20 character backlit display using plain English text readout. In addition to programming the standard parameters such as starting torque, ramp time, current limit and decel control, other features such as programmable overload trip curves (NEMA/UL Classes 5 - 30) and inhibits that include starts-per-hour, time between starts and coast down/back spin lockout protection, can also be programmed for your specific application needs.

1.2 Specifications

GENERAL	
Type of Load	Three phase AC Induction motors or synchronous motors
Unit Running Overload Capacity (Percent of motor FLA)	125% - Continuous, 500% - 60 seconds or 600% - 30 seconds
Frequency	50 or 60Hz, +2Hz hardware selectable
Power Circuit	6 SCRs
SCR Peak Inverse Voltage Ratings	1600V
Phase Insensitivity	Unit operates with any phase sequence
Transient Voltage Protection	RC snubber dv/dt networks on each phase
Bypass Contactor	Shunt rated contactor included as standard in all NEMA 12 enclosed units 92A and above. Also standard with all NEMA 12 combination starters. Line start rated contactor available as an option.
Ambient Condition Design	Enclosed units: 0° to 40°C (32° to 104°F) 5 - 95% relative humidity 0 - 3300 ft. (1000m) above sea level without derating.
Control	2 or 3 wire 120VAC (Customer supplied)
Auxiliary Contacts	Type/Rating: Form C (SPDT), rated 5 Amps, 240VAC max. (1200VA) 4 Programmable Relays
Approvals	UL & Canadian UL (cUL)

Specifications – Continued

ADVANCED MOTOR PROTECTION	
Two Stage Electronic Overload Curves	Starting: Programmable for Class 5 through 30 Runing: Programmable for Class 5 through 30
Overload Reset	Manual (default) or Remote
Retentive Thermal Memory	Overload circuit retains thermal condition of the motor regardless of control power status. Unit uses real time clock to adjust for off time.
Dynamic Reset Capacity	Overload will not reset until thermal capacity available in the motor is sufficient for a successful restart. Starter learns and retains this information by monitoring previous successful starts.
Phase Current Imbalance Protection	Imbalance Trip Level: 5 - 30% current between any two phases Imbalance Trip Delay: 1 -20 seconds
Over Current Protection (Electronic Shear Pin)	Trip Level: 100 - 300% of motor FLA Trip Delay: 1 - 20 seconds
Load Loss Trip Protection	Under Current Trip Level: 10 -90 % of motor FLA Under Current Trip Delay: 1 - 60 seconds
Coast Down (Back Spin) Lockout Timer	Coast Down Time Range: 1 - 60 minutes
Starts-per-hour Lockout Timer	Range: 1 - 10 successful starts per hour Time between starts: 1 - 60 minutes between start attempts

PROGRAMMABLE OUTPUTS	
Type / Rating	Form C (DPDT), Rated 5 amps 240 VAC max (960 VA)
Run Indication	Programmable
At Speed Indication	Programmable
Acceleration Adjustments	Programmable Ramp Types: Voltage, Current or Power Ramp (VR or CR) Starting Torque: 0 - 100% of line voltage (VR) or 0 - 600% of motor FLA (CR) Ramp Time: 1 to 120 seconds Current Limit: 200 - 600% (VR or CR) Power Ramp: 0 – 300%
Dual Ramp Settings	4 Options: VR1+VR2; VR1+CR2; CR1+CR2; CR1+VR2 Dual Ramp Control: Ramp 1 = Default Ramp 2 = selectable via dry contact input
Deceleration Adjustments	Begin Decel Level: 0 - 100% of line voltage Stop Level: 0 to 1% less than Begin Decel Level Decel Time: 1 - 60 seconds
Jog Settings	Voltage Jog: 5 - 100%
Kick Start Settings	Kick Voltage: 10 - 100% Kick Time: 0.1 - 2 seconds
Fault Display	Phase Loss, Shunt Trip, Phase Imbalance Trip, Overload, Overtemp, Overcurrent, Short Circuit, Load Loss, Undervoltage or Any Trip
Lockout Display	Coast Down Time, Starts Per Hour, Time Between Starts, and Any Lockout

EVENT HISTORY	
Up to 60 Events	Data includes cause of event, time, date, voltage, power factor and current for each phase and ground fault current at time of event

Specifications – Continued

METERING FUNCTIONS	
Motor Load	Percent of FLA
Current Data	A, B, C Phase Current, Avg Current, Ground Fault
Thermal Data	Remaining thermal register; thermal capacity to start
Start Data	Avg Start Time, Avg Start Current, Measured Capacity to start, time since last start.
RTD Data (Option)	Temperature readings from up to 12 RTDs (6 stator RTDs)
Voltage Metering	kW, kVAR, PF, kWh

SERIAL COMMUNICATIONS	
Protocol	Modbus RTU
Signal	RS-485, RS-422 or RS232
Network	Up to 247 devices per mode
Functionality	Full operation, status view, and programming via communications port

OPERATOR INTERFACE	
LCD Readout	Alpha numeric LCD display
Keypad	8 function keys with tactile feedback
Status Indicators	12 LEDs include Power, Run, Alarm, Trip, 4 Aux Relays
Remote Mount Capability	Up to 1000 feet from chassis (Use twisted, shielded wire & power source)

CLOCK and MEMORY	
Operating Memory	SRAM loaded from F-RAM at initialization
Factory Default Storage	Flash EEPROM
Customer Settings and Status	Non-volatile FRAM, no battery backup necessary
Real Time Clock	Lithium ion battery for RTC only

1.3 Reference chart

SEC.	Table or Drawing	Page Number	SEC.	Table or Drawing	Page Number
1.2	Specifications	4			
2.7	Power Connections	14			
2.8	Control Connections	14			
2.9a	Optional RTD Board	16			
2.9b	Power Board	17			
2.9c	CPU Board	18			
2.9d	Communication Board	19			
3.3	Acceleration Adjustments	20			
3.4	Deceleration Adjustments	21			
3.5	Sequence of Operation	23			
4.1	Keypad Operator Interface	24			
4.2	Menu Navigation	25			
	Changing Setpoints Example	26			
5.1	Setpoints Page List	27			
5.2	Setpoint Menu & Parameter Explanation	27			
	Setpoint Page 1 Displays - Basic Configuration	27			
	Overload Class Trip Curves	35			
	Setpoint Page 2 Displays - Starter Configuration	27			
	Jog/Voltage Ramp	37			
	Setpoint Page 3 Displays - Phase & Ground Settings	28			
	Setpoint Page 4 Displays - Relay Assignment	29			
	Setpoint Page 5 Displays - Relay Configuration	30			
	Setpoint Page 6 Displays - User I/O Configuration	30			
	Setpoint Page 7 Displays – Custom Acceleration Curve	31			
	Setpoint Page 8 Displays – Overload Curve Configuration	31			
	Setpoint Page 9 Displays – RTD Option Configuration	32			
	Setpoint Page 10 Displays – Set Password	33			
			5.2	Setpoint Page 11 Displays - Communications	33
				Setpoint Page 12 Displays – System Setpoints	33
				Setpoint Page 13 Displays – Calibration & Service	33
			6.1	Metering Page List	62
			6.2	Metering Menu	62
				Metering Page 1 Displays - Metering Data	62
				Metering Page 2 Displays - Metering	62
				Metering Page 3 Displays - RTD Values	62
				Metering Page 4 Displays - Status	63
				Metering Page 5 Displays - Event Recorder	63
				Metering Page 6 Displays - Last Trip	63
				Metering Page 7 Displays - Statistics	64
			7.1	Failure Analysis & Troubleshooting SCR Testing Procedure	73

1.4 Theory of Operation

The power of the **DXT Series** is in the CPU, a microprocessor based protection and control system for the motor and starter assembly. The CPU uses Phase Angle Firing of the SCRs to apply a reduced voltage to the motor. Then slowly and gently increases torque through control of the voltage and current until the motor accelerates to full speed. This starting method lowers the starting current of the motor, reducing electrical stresses on the power system. It also reduces peak starting torque stresses on both the motor and mechanical load components, promoting longer service life and less downtime.

1.4.1 Acceleration:

The **DXT Series** comes standard with several methods of accelerating the motor which allow it to be programmed to match almost any industrial AC motor application.

The factory default setting applies a **Voltage Ramp** with **Current Limit** as this has been proven the most reliable starting method for the vast majority of applications. Using this starting method, the Initial Torque setting applies just enough voltage to the motor to cause the motor shaft to begin to turn. This voltage is then gradually increased over time (as per the Ramp Time setting) until one of two things happen: the motor accelerates to full speed, or the Ramp Time expires and the Current Limit setting is reached.

If the motor accelerates to full speed before the ramp time setting has expired, an automatic Anti-Oscillation feature will override the remaining ramp time and full voltage will be applied. This will prevent any surging or pulsation in the motor torque, which might otherwise occur due to the load not being fully coupled to the motor when operating at reduced voltage and torque levels.

If the motor has not reached full speed at the end of the ramp time setting, the current limit setting will proportionally control the maximum output torque. Feedback sensors and protection algorithms in the **DXT Series** provide protection from a stall condition, an overload condition or excessive acceleration time.

The Current Limit feature is provided to accommodate installations where there is limited power available (for example, on-site generator power or utility lines with limited capacity). The torque is increased until the motor current reaches the pre-set Current Limit point and it is then held at that level. Current Limit overrides the ramp time setting so if the motor has not accelerated to full speed under the Current Limit setting, the current remains limited for as long as it takes the motor to accelerate to full speed.

When the motor reaches full speed and the current drops to running levels, the **DXT Series** detects an At-Speed condition and will close a Bypass Contactor (if provided). The Bypass Contactor serves to shunt power around the SCR stack assemblies to prevent heat build-up NEMA12 enclosed units and combination starters due to the slight voltage drop across the SCRs. At this point, the **DXT Series** has the motor operating at full voltage, just as any other starter would.

Other starting methods available in the DXT Series are:

- **Current Ramp:** Uses a closed loop current feedback algorithm to provide a linear current increase up to a Maximum Current level.
- **Constant Current:** Current is immediately increased to the Current Limit point and held there until the motor reaches full speed.
- **Power (KW) Ramp:** Uses a True RMS KW feedback PID loop to provide a linear increase in True RMS motor power to a maximum set KW value.
- **Custom Curve:** Gives the user the ability to plot torque and time points on a graph. The DXT Series will then accelerate the motor following these points.
- **Tachometer Feedback Ramp:** Uses a closed loop speed follower method monitoring a tachometer input signal from the motor or load shaft to provide a linear RPM acceleration.

1.4.2 Deceleration: The *DXT Series* provides the user with the option of having the load coast to a stop or controlling the deceleration by slowly reducing the voltage to the motor upon initiating a stop command. The Decel feature is the **opposite of DC injection braking** in that the motor will actually take longer to come to a stop than if allowed to coast to a stop. The most common application for the Decel feature is pumping applications where a controlled stop prevents water hammer and mechanical damage to the system.

1.5 General Protection

The DXT Series is provided with a built-in motor protection relay that can be programmed for primary protection of the motor / load system. Operation of the DXT Series can be divided into 4 modes; Ready, Start, Run and Stop.

1.5.1. Ready Mode: In this mode, control and line power are applied and the Starter is "READY" for a start command.

Protection during this mode includes the monitoring of current for leakage through multiple shorted SCRs or welded contacts on the Bypass Contactor. Other protection features in effect are:

- SCR Heat Sink Temperature
- Shorted SCR
- Phase Rotation (if enabled)
- Line Frequency Trip Window
- External Input Faults (Digital Input Faults are active in all modes)

Note: The "Programming Mode" can only be entered from the Ready Mode. Any attempt to enter data while the motor is starting or running will be blocked. During programming, all protection features and start command are disabled.

1.5.2 Start Mode: These additional protection functions are enabled when the DXT Series receives a valid Start command:

- Phase Rotation (if enabled)
- Start Curve
- Acceleration Timer
- Phase Imbalance
- Short Circuit / Load Pre-check (Toe-in-the-Water)
- Ground Fault (Optional)
- External Input Faults
- Accumulated Starting FLA Units (I2t Protection)
- Starting Overload Protection Curve Selection
- Thermal Capacity

Note: Shorted SCR and Shunt Trip protection are no longer in effect once the DXT Series goes into the Start Mode.

1.5.3 Run Mode: The *DXT Series* enters the Run Mode when it reaches full output voltage and the motor current drops below the FLA setting (motor nameplate FLA plus service factor) for a pre-determined period of time. During the Run Mode these additional protection features are enabled:

- Running Overload Protection Curve Selection
- Phase Loss
- Under Current / Load Loss
- Over Current / Electronic Shear Pin (Jam Protection)
- External Input Faults

1.5.4 Stop Mode: Once a Stop command has been given, the *DXT Series* protection features change depending on which Stop Mode is selected.

- Decel Mode: Retains all protection features of the Run Mode. At the end of Decel, the motor will be stopped and the protection features change as indicated below.
- Coast-To-Stop Mode: Power is immediately removed from the motor and the DXT Series returns to the Ready Mode.
- Additional protection features activated when the stop command is given include:
 - Coast-Down / Back Spin Timer
 - Starts-per-Hour
 - Time between Starts
 - External Input Faults

1.6 Thermal Overload Protection

The *DXT Series* plays an important role in the protection of your motor in that it monitors the motor for excessive thermal conditions due to starting, running and ambient conditions. The DXT Series has a Dynamic Thermal Register system in the CPU that provides a mathematical representation of the thermal condition of the motor.

This thermal information is retained in memory and is monitored for excesses in both value and rate of change. Inputs are derived from current values, imbalances and (optional) RTD measurements making it dynamic to all processes involving the motor. The DXT Series monitors these conditions separately during the Start and Run modes to provide proper thermal protection at all times.

1.6.1 Start Mode overload protection is selectable using one of three methods:

- **Basic Protection:** I²t data is accumulated and plotted based on an Overload Curve selected in programming. This is programmed per NEMA Class 5-30 standard curves and is based on the Motor FLA (from the motor nameplate) as programmed into the DXT Series.
- **Measured Start Capacity:** The user enters a measured amount of thermal capacity from a pre-selected successful start as a set point to the Thermal Register for the DXT Series to follow.
- **Learned Curve Protection:** The user sets the DXT Series to the “LEARN” mode and starts the motor under normal starting conditions. The CPU then samples and records 100 data points during the start curve, analyzes them and creates a graphical representation in memory. The DXT Series is then switched to Curve Follow protection mode and monitors motor performance against this curve. This feature is especially useful in initial commissioning tests to record a base line performance sample (In this case, it is not necessarily used for motor protection).

1.6.2 Run Mode overload protection is initiated when the **DXT Series** determines that the motor is At-Speed. Overload Protection is initiated when the motors' RMS current rises above a "pick-up point" (as determined by the motor nameplate FLA and service factor). Run mode protection is provided by the CPU monitoring the Dynamic Thermal Register. Data for the Dynamic Thermal Register is accumulated from I²t calculations and cooling rates. A trip occurs when the register reaches 100% as determined by the selected Overload Protection Curve (NEMA Class 5-30 standard curves) and is based on the programmed Motor FLA indicated on the motor nameplate. The Dynamic Thermal Register is altered, or "biased", by the following conditions:

- **Current Imbalance** will bias the register higher due to additional motor heating as a result of a line current imbalance condition.
- **Normal Cooling** is provided when the motor current drops below the overload pick-up point or the motor is off line. The Cooling rate is lower for motors that are off-line (such as after a trip) since cooling fans are also inoperative.
- **RTD Input** (Requires the optional RTD monitor card) provides a separate means of motor protection based on actual temperature measurements inside the motor. It runs independently of the Thermal Register Model and does not provide input to, or bias that model. Both the RTD monitor card and internal overload algorithm run simultaneously and either one can generate a trip if the individual conditions are met.
- **Dynamic Reset** is another feature that adds reliability and consistency to the performance of the DXT Series. If a motor overload condition occurs and the Overload protection trips, it cannot be reset until sufficient cool down time has elapsed. This cool down time is determined by the "Learned Thermal Capacity" required to start the motor which must be regained before the overload can be reset. This ensures sufficient thermal capacity for a successful restart of the motor.
- **Retentive Memory** provides continuous overload protection and true thermal modeling by means of a running back up of the thermal register even if power is lost. Upon restoration of power, the **DXT Series** will read the Real Time Clock, then recalculate and restore the thermal register to what it should be, given the elapsed time and the cool down rate of the motor.
- **Learned Reset Capacity** is a feature that is unique to the **DXT Series**. By sampling the amount of thermal capacity used in the previous three successful starts, the starter will not allow a reset until a sufficient amount of thermal capacity has been regained in the motor. This prevents nuisance tripping and insures that unsuccessful start attempts (which would otherwise use up the starts-per-hour capacity of the motor) are not counted.

Chapter 2 - Installation

2.1 Receiving and Unpacking

Upon receipt of the unit:

- Carefully unpack the unit and inspect it for any shipping damage. Report any damage immediately and file a claim with the freight carrier within 15 days of receipt.
- Verify that the model number on your unit matches your purchase order.
- Confirm that the ratings label on the unit matches or is greater than the motor's HP and current rating (FLA + SF).

2.2 Initial Unit Inspection

- Make a complete visual check of the unit for damage which may have occurred during shipping and handling. Do not attempt to continue installation or start up the unit if it is damaged.
- Check for loose mechanical assemblies or broken wires which may have occurred during transportation or handling. Loose electrical connections will increase resistance and cause the unit to function improperly.
- Prior to beginning the installation, verify that the motor and DXT unit are rated for the proper amperage and voltage.

2.3 Location

The proper location of the unit is an important factor in achieving the unit's specified performance and normal operation lifetime. The unit should always be installed in an area where the following conditions exist:

- Ambient Operating Temperature: 0° C to 50° C (32° F to 122° F)
(Optional space heaters can be provided for operation in ambient temperature to -20° C.)
- Protected from rain and moisture.
- Humidity: 5% to 95% non-condensing.
- Free from metallic particles, conductive dust and corrosive gas.
- Free from excess vibration (below 0.5G)
- Open panel units must be mounted in the appropriate type of enclosure. Enclosure size and type must be suitable to dissipate heat generated by the DXT Series. Contact factory for assistance in sizing the enclosure.

Warning!



Do not service equipment with voltage applied! The unit can be the source of fatal electrical shocks! To avoid shock hazard, disconnect main power and control power before working on the unit. Warning labels must be attached to terminals, enclosure and control panel to meet local codes.

2.4 Mounting and Cleaning

When drilling or punching holes in the enclosure, cover the electrical assembly to prevent metal filings from becoming lodged in areas which can cause clearance reduction or actually short out electronics. After work is completed, thoroughly clean the area and re-inspect the unit for foreign material. Make sure there is sufficient clearance (six inches) all around the unit for cooling, wiring and maintenance purposes. To maximize effective air flow and cooling, the unit must be installed with its heat sink ribs oriented vertically and running parallel to the mounting surface.



Warning! Remove all sources of power before cleaning the unit!

In dirty or contaminated atmospheres the unit should be cleaned on a regular basis to ensure proper cooling. Do not use any chemicals to clean the unit. To remove surface dust use 80 to 100 psi, clean, dry compressed air only. A three inch, high quality, dry paint brush is helpful to loosen up the dust prior to using compressed air on the unit.

2.5 Power Terminal Wire Range and Tightening Torque

Model Number	Max Amps	Max HP				KW		Terminal Wire Range	Torque lbs/in
		208V	230V	480V	600V	230V	400V		
DXT-39	39	10	-	25	30	11	18.5	#18 - #4	20
DXT-48	48	10	15	30	40		22		
DXT-62	62	15	20	40	50	15	30	#14 - #2	50
DXT-78	78	20	25	50	60	22	37		
DXT-92	92	25	30	60	75		45	#14 - #1/0	50
DXT-120	120	30	40	75	100	30	55		
DXT-150	150	40	50	100	125	45	75	#6 - 250 kcmil	275
DXT-180	180	50	60	125	150	55	90		
DXT-220	220	60	75	150	200		110	(2) #6 - 250 kcmil	275
DXT-288	288	75	100	200	250	75	132		
DXT-360	360	100	125	250	300	110	160	(2) #2 - 600kcmil	375 in lbs
DXT-414	414	125	150	300	350		200		
DXT-476	476	-	-	350	400	132	250		
DXT-550	550	150	200	400	500	160			
DXT-718	718	200	250	500	600	200	315	(3) #2 - 600 kcmil	375
DXT-862	862	250	300	600	700		400		
DXT-1006	1006	300	350	700	800				
DXT-1150	1150	350	400	800	900			(4) 1/0 - 750kcmil	500
DXT-1200	1200	400	450	900	1000				
DXT-1250	1250	450	500	1000	1125				

Note: All wiring must be sized according to NEC standards

2.6 Dimensions

DXT DIMENSIONS							
Enclosure	Model Number	Overall Dimensions			Mounting Dimensions		
		A	B	C	D	E	F
PANEL	DXT-39 to DXT-120	16.5	10	10	15.9	9	0.28
	DXT-150 to DXT-180	20	20.1	12	18.5	17.5	0.44
	DXT-220 to DXT-288	27	20.1	11.2	25.5	17.5	0.44
	DXT-360 to DXT-550	29.5	20.1	11.5	25.5	17.5	0.44
	DXT-718 to DXT-1006	45	33	12.8	43.3	31.3	0.44
	DXT-1150 to DXT-1250	33	33	15.2	31.2	31.2	0.44
NEMA1	DXT-39 to DXT-120	16.5	10	10	15.9	9	0.28
	DXT-150 to DXT-180	32.3	24.3	13.3	31.3	18	0.44
	DXT-220 to S1-288	38.3	24.3	13.3	37.3	18	0.44
	DXT-360 to DXT-550	44.3	30.3	13.3	43.3	24	0.44
	DXT-718 to DXT-1006	50.2	36.3	15.5	49.3	30	0.4
	DXT-1150 to DXT-1250	Contact Factory			Contact Factory		
NEMA 4/4X	DXT-39 to DXT-78	15.7	12.2	10	12	11	0.28
NEMA12	DXT-92 to DXT-120	24	24	12.9	22.5	22.5	0.5
	DXT-150 to DXT-288	36	30	16.9	34.5	28.5	0.5
	DXT-360 to DXT-550	48	36	16.9	46.5	34.5	0.5
	DXT-718 to DXT-1006	72.1	48.1	20	Floor Mounted		
	DXT-1150 to DXT-1250	Contact Factory			Contact Factory		

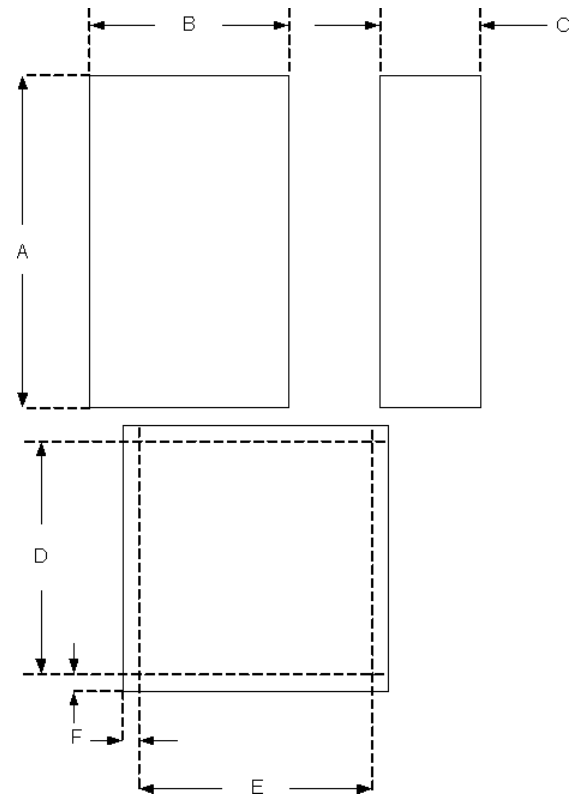

2.7 Power Connections

Connect appropriate power lines to the unit input terminals marked L1, L2, and L3. Avoid routing power wires near the control board. Connect the motor leads to the unit terminals marked T1, T2, and T3. Refer to NEC standards for wire length and sizing. Never interchange input and output connections to the unit. This could cause excessive voltage in the control logic circuit and may damage the unit.



Note: Never connect power factor correction capacitors on the load side of the unit. The SCRs will be seriously damaged if capacitors are located on the load side.

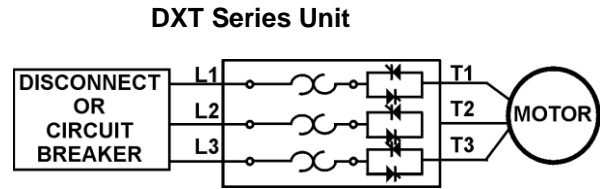

Power Connection

The unit must be tested with a motor or other test load connected to the load side of the unit. (A load bank can be used if a motor is not available). Note that line voltage will appear across the output terminals if there is no motor or load connected to the unit. In areas where lightning is a significant problem, station-type lightning arrestors should be considered and utilized on the input power source.

2.7.1 Grounding

Connect the ground cable to the ground terminal as labeled on the unit. Refer to the National Electrical Code for the proper ground wire sizing and be sure that the ground connector is connected to earth ground.

2.8 Control Connections

Separate 120VAC supply is required (240VAC available as option). The control voltage should be connected to pins 1 and 6 of TB4 on the power board. Note: On larger units TB4 is factory wired to the panel to facilitate connections. This control voltage must be customer supplied, unless an optional control power transformer (See chart) has been supplied with the unit.

DXT Model (by Amps)	Recommended Transformer Sizes		
	Panel	NEMA 1	NEMA 4/12
DXT-150 to DXT-180	50 VA	100 VA	250 VA*
DXT-220	50 VA	100 VA	500 VA*
DXT-288 to DXT-360	250 VA	250 VA	500 VA*
DXT-414 to DXT-550	250 VA	250 VA	750 VA*
DXT-718 to DXT-862	500 VA	500 VA	1 KVA*
DXT-1006 to DXT-1150	500 VA	750 VA	1.5 KVA*
DXT-1200 to DXT-1250	500 VA	750 VA	1.5 KVA*

* Transformer size is adequate to power built-in bypass contactors on these models.
Recommended Transformer Sizes for Control Power

2.8.1 Three-Wire Connection

Connect N.C. (normally closed) stop button between pins 3 and 4 of TB4.
Connect N.O. (normally open) start button between pins 4 and 5 of terminal block TB4.

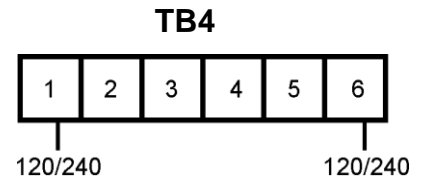

Unit comes standard with 120VAC control. Order 240VAC control as an option if required.

Three-Wire Connection.

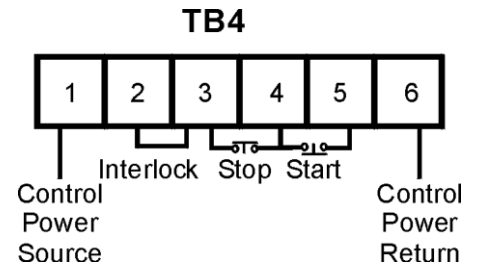

2.8.2 Two-Wire Connection

An alternate connection for unattended operation replaces start/stop push buttons by connecting a maintained contact closure between pins 3 and 5 on TB4. When the maintained contact is used for start/stop it is necessary to set the overload setpoint to the manual reset position. This will prevent the motor from restarting if the thermal overload trips and then cools off.

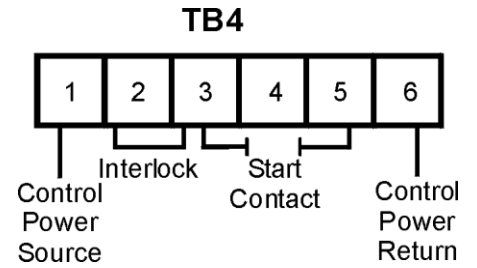

Two-Wire Connection.



Warning!
When two-wire connection method is used, the start circuit must be interlocked to prevent automatic restart when either of the two protective devices (overload or thermostat) reset. Thermostats always automatically reset on cool down.

2.8.3 Programmable Relays/Relay Contacts

All the relay contacts are FORM C (Com, N.O. and N.C.). It is recommended fusing all contacts with external fuses. The **DXT** has four programmable relays on TB3 on the power board. The relays are rated for 240 VAC, 5 A and 1200 VA. These relays can respond to either a fault condition or an up-to-speed condition. In the DXT all tripping functions have been assigned to the TRIP (AUX1) relay, and all alarm (warning) conditions have been configured to the ALARM (AUX2) relay.

AUX 3 is used for a MOTOR RUNNING indication. The relay contact will energize when the start command has been given and de-energizes when a stop or fault condition occurs. AUX4 is the AT SPEED contact. When the motor has reached the end of its acceleration ramp, the **DXT** will wait until the AT SPEED programmed time delay has expired. Then, the relay will energize until a stop command has been received. To change AUX3 or AUX4 functions, see Setpoint Page 4.

TB3	1	2	3	4	5	6	7	8	9	10	11	12
	C	N.O.	N.C.	C	N.O.	N.C.	C	N.O.	N.C.	C	N.O.	N.C.
	AUX1 (TRIP) Relay			AUX2 (ALARM) Relay			AUX3 (RUN) Relay			AUX4 (AT SPEED) Relay		

**Relay Contacts on Power Board
 Rated 240 VAC, 5A, 1200VA**

2.9 Reference Section - THIS SECTION IS FOR REFERENCE ONLY. NO FIELD WIRING OR CONNECTIONS ARE REQUIRED.

2.9a Optional RTD Board

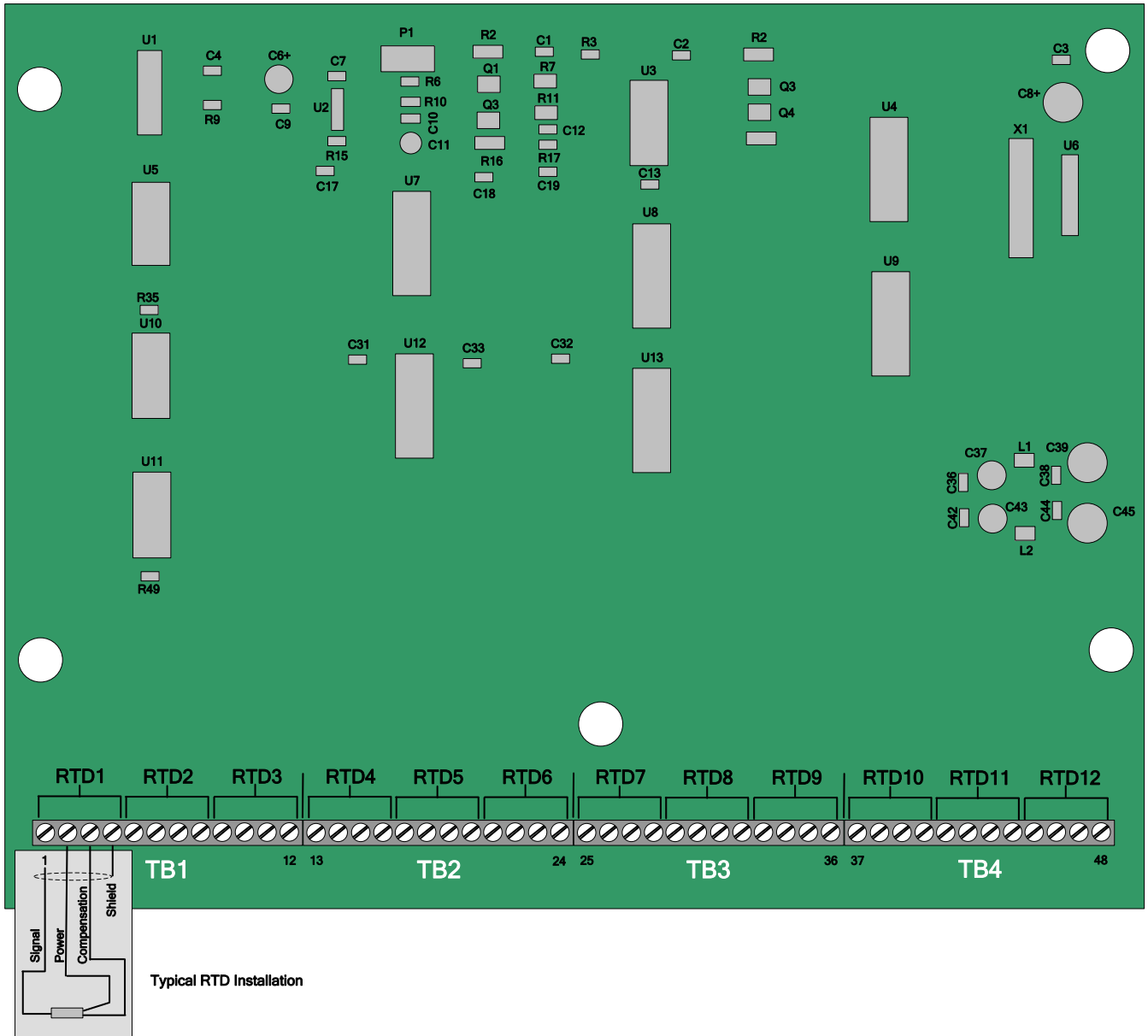
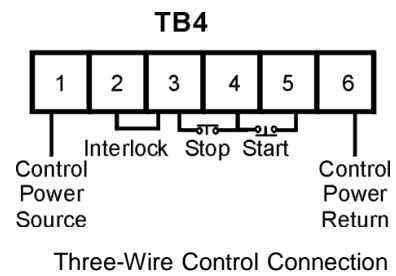
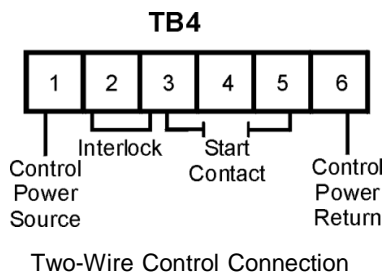
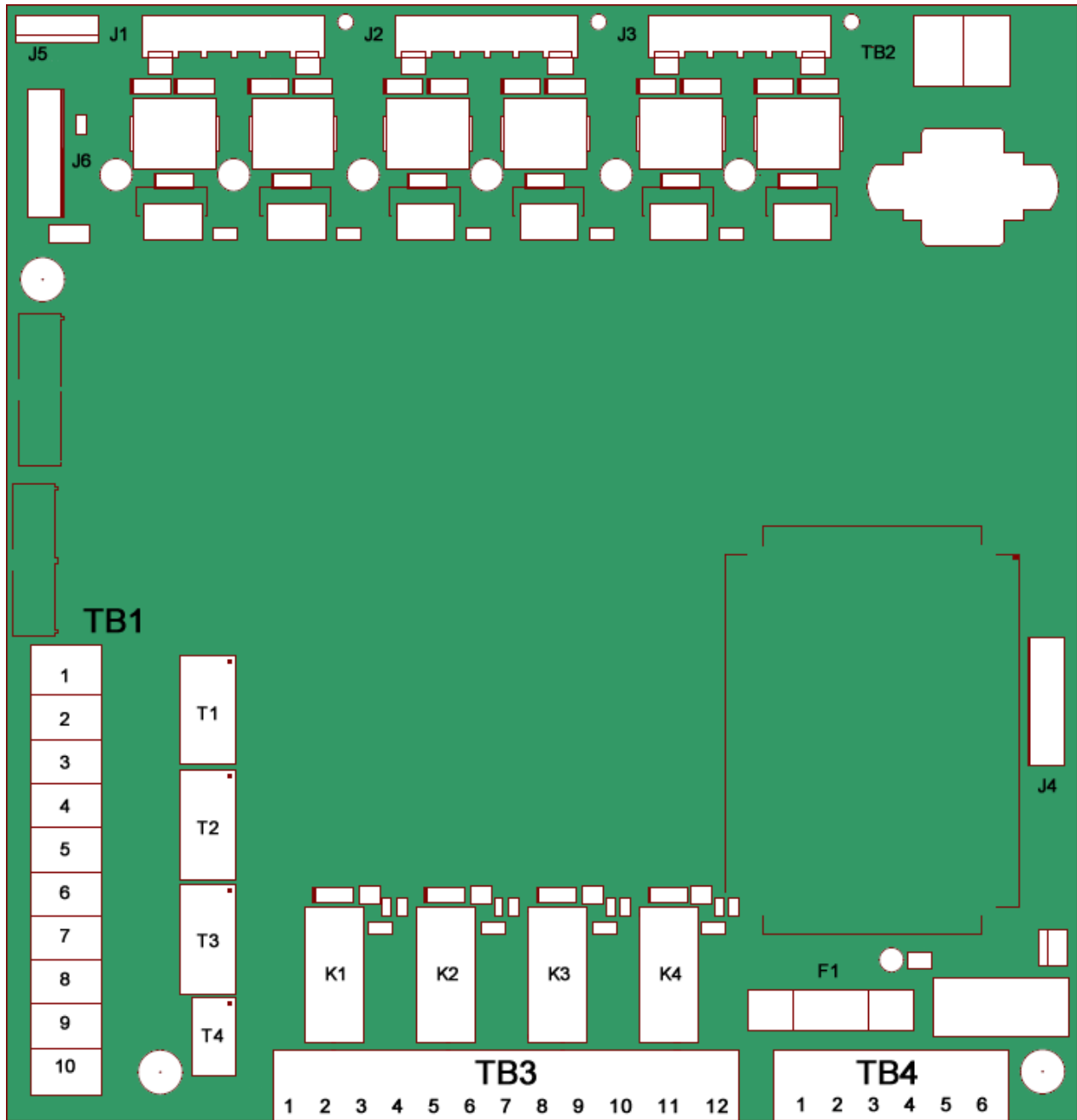

FIG. 2.9a Optional RTD Board

2.9b Power Board



Relay Contacts on Power Board
 Rated 240 VAC, 5A, 1200VA

2.9c CPU Board Connections

There are eight digital inputs on the CPU board. Four of the inputs are user programmable. There are also two analog outputs and a tachometer feedback input.

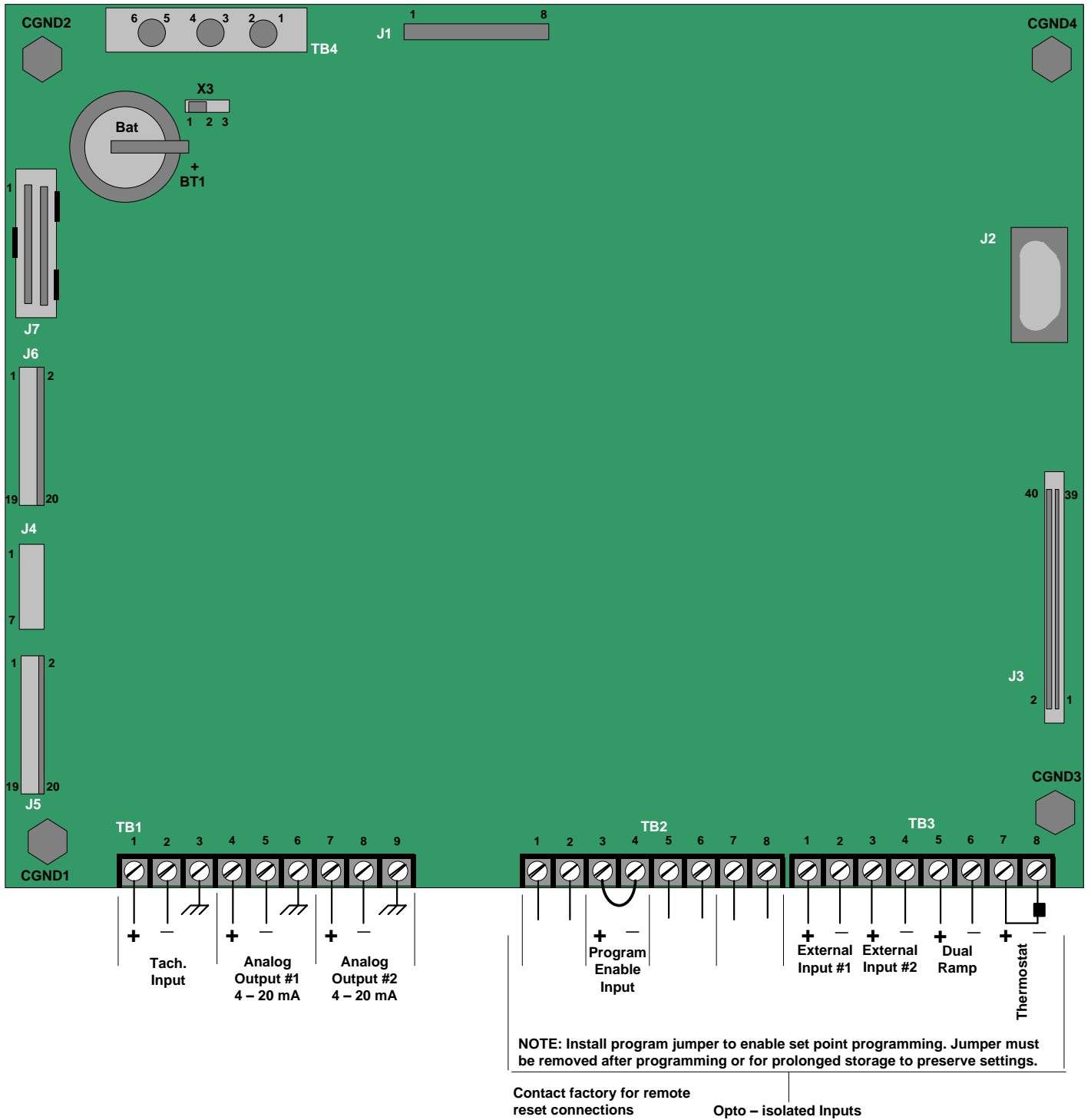

FIG. 2.9c CPU Board

2.9d Communication Board

Note: This Board is mounted on the back of the Keypad Interface

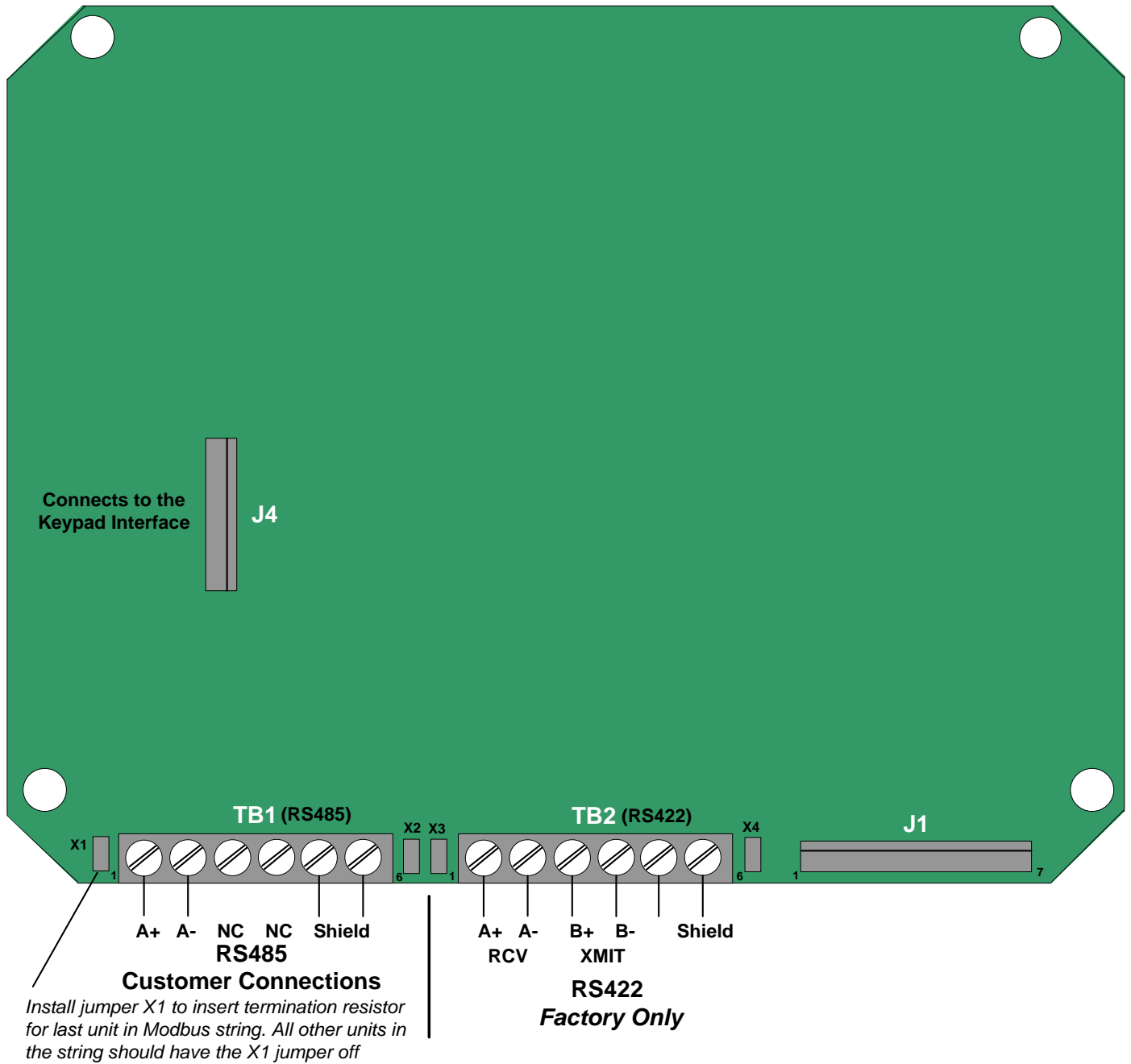

FIG. 2.9d RS485 / RS422 Communications Board

Chapter 3 - Start-up



WARNING! THE DXT UNIT DEALS WITH POTENTIALLY LETHAL VOLTAGE LEVELS. YOU MUST BE CERTAIN THAT PERSONNEL ARE THOROUGHLY TRAINED IN THE APPLICABLE SAFETY PRECAUTIONS BEFORE PROCEEDING WITH THIS SECTION!

3.1 Preliminary Start-Up Check List

Please make the following checks before applying power to the unit:

- Supply voltage matches the rated supply voltage of the unit.
- Horsepower and current ratings of the motor and unit match or the unit has a higher rating.
- Initial ramp time and torque adjustments have been checked.
- Power lines are attached to the unit input terminals marked L1, L2 and L3.
- Motor leads are connected to the lower terminals marked T1, T2 and T3.
- Appropriate control power is applied and/or control connections have been made.
- The motor's FLA has been programmed.
- The thermal overload parameters are properly set.
- The motor area and equipment are clear of people and parts before start-up.

3.2 Introduction

It is best to operate the motor at its full load starting condition to achieve the proper time, torque and ramp settings. Initial settings are set to accommodate most motor conditions. **TRY INITIAL SETTINGS FIRST**. See Setpoint Page 2 to make any adjustments.

3.3 Acceleration Adjustments

The unit is set at the factory with typical starting characteristics that perform well in most applications. When the system is ready to start, try the initial unit settings. If the motor does not come up to speed, increase the current limit setting. If the motor does not start to turn as soon as desired, raise the starting voltage adjustment. Adjustment description and procedures are described as follows (See section 5.2 SP 2.1).

3.3.1 Starting Voltage

Factory Setting = 20% of line voltage

Range = 0% - 100% of line voltage

Starting voltage adjustment changes the initial starting voltage level to the motor.

3.3.2 Ramp Time

Factory Setting = 10 sec. Range = 0 - 120 sec.

Ramp time adjustment changes the amount of time it takes to reach the current limit point or full voltage if the current limit point was not reached.

3.3.3 Current Limit

Factory Setting = 350% of programmed FLA

Range = 200% - 600% of programmed FLA

The main function of current limit is to cap the starting current. It may also be used to extend the ramping time if required. The interaction between the voltage ramp and the current limit will allow the soft start to ramp the motor until the maximum current is reached and the current limit will hold the current at that level. The current limit must be set high enough to allow the motor to reach full speed. The factory setting of 350% is a good starting point. Do not set the current limit too low on variable starting loads. This could cause the motor to stall and eventually cause the overload protection to trip.

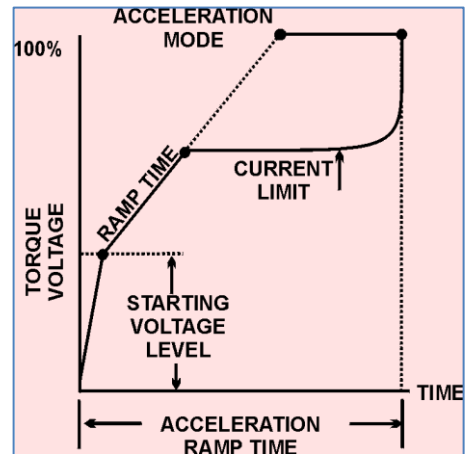

3.4 Deceleration Adjustments (Pump Control)

Decel extends the stopping time on loads that would otherwise stop too quickly if allowed to coast to stop. Decel control provides smooth deceleration until the load comes to a stop. Three adjustments optimize the deceleration curve to meet the most demanding requirements. Try factory settings before adjusting.

Deceleration Applications

The unit is shipped from the factory with the decel feature disabled. Apply power and adjust the soft start before enabling or modifying the deceleration adjustments. Both acceleration and deceleration adjustments should be made under normal load conditions.

The deceleration feature provides a slow decrease in the output voltage, accomplishing a gentle decrease in motor torque during the stopping mode. This is the OPPOSITE OF BRAKING in that it will take longer to come to a stop than if the starter were just turned off. The primary use of this function is to reduce the sudden changes in pressure that are associated with "Water Hammer" and slamming of check valves with centrifugal pumps. Decel control in pump applications is often referred to as Pump Control.

In a pump system, when liquid is being pushed uphill. The force exerted by gravity on the column of liquid as it goes up hill is called the "Head Pressure" in the system. The pump is sized to provide enough Output Pressure to overcome the Head Pressure and move the fluid up the pipe. When the pump is turned off, the Output Pressure rapidly drops to zero and the Head Pressure takes over to send the fluid back down the hill. A "Check Valve" is used somewhere in the system to prevent this (if necessary) by only allowing the liquid to flow in one direction. The kinetic energy in that moving fluid is suddenly trapped when the valve slams closed. Since fluids can't compress, that energy is transformed into a "Shock Wave" that travels through the piping system looking for an outlet in which it dissipates. The sound of that shock wave is referred to as "Water Hammer". The energy in that shock wave can be extremely damaging to pipes, fittings, flanges, seals and mounting systems.

By using the Soft Stop/Deceleration feature of the DXT, the pump output torque is gradually and gently reduced, which slowly reduces the pressure in the pipe. When the Output Pressure is just slightly lower than the Head Pressure, the flow slowly reverses and closes the Check Valve. By this time there is very little energy left in the moving fluid and the Shock Wave is avoided. When the output voltage to the motor is low enough to no longer be needed, the DXT will end the Decel cycle and turn itself off.

Another common application for decel control is on material handling conveyors as a means to prevent sudden stops that may cause products to fall over or to bump into one another. In overhead crane applications, soft stopping of the Bridge or Trolley can prevent loads from beginning to over swing on sudden stops.

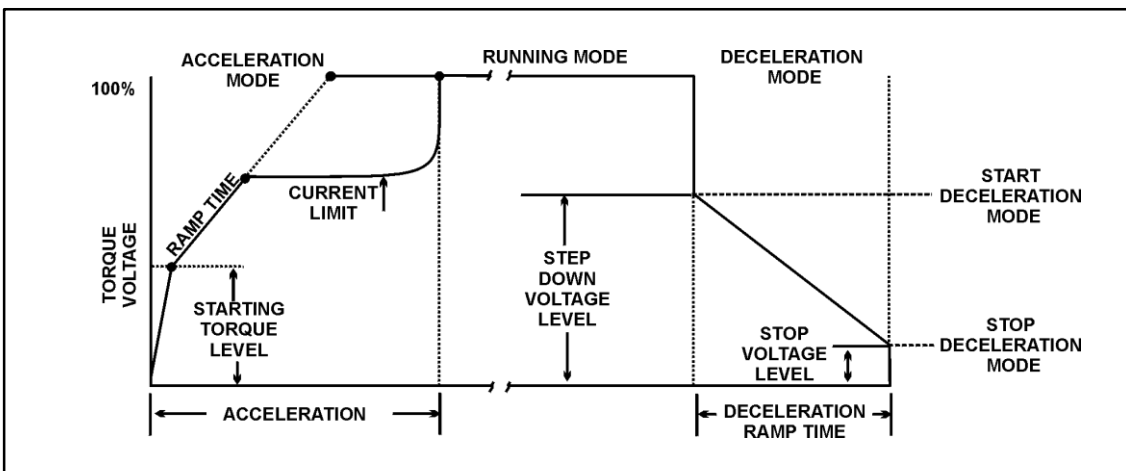

3.4.1 Start Deceleration Voltage

Factory Setting = 60% of line voltage

Range = 0% - 100% of line voltage

The step down voltage adjustment eliminates the dead band in the deceleration mode that is experienced while the voltage drops to a level where the motor deceleration is responsive to decreased voltage. This feature allows for an instantaneous drop in voltage when deceleration is initiated.

3.4.2 Stop Deceleration Voltage

Factory Setting = 20% of line voltage

Range = 0% - 100% of line voltage

The stop voltage level setpoint is where the deceleration voltage drops to zero.

3.4.3 Deceleration Time

Factory Setting = 5 sec. Range = 0 - 60 sec.

The deceleration ramp time adjusts the time it takes to reach the stop voltage level set point. The unit should be restarted and stopped to verify that the desired deceleration time has been achieved.



WARNING! DO NOT EXCEED THE MOTOR MANUFACTURER'S RECOMMENDED NUMBER OF STARTS PER HOUR. WHEN CALCULATING THE NUMBER OF STARTS PER HOUR, A DECEL CURVE SHOULD BE COUNTED AS A START CURVE. FOR EXAMPLE: RECOMMENDED NUMBER OF STARTS PER HOUR = 6, ALLOWABLE STARTS WITH DECEL CYCLE PER HOUR = 3.

3.5 Sequence of Normal Operation

- Apply control power and check that the “Power” LED comes on.(Display 1)
- Apply three phase power to the unit. The motor should run only when the start command is applied.
- Apply the start command. (Display 2). The RUN LED will be lit.(Display 3)
- The AUX3 LEDs will be lit. If the motor does not enter run mode in the set time, a trip will occur.
- The POWER, RUN, AUX3 LEDs will be lit, indicating that the contact has energized. IA, IB, IC will display the current setting for Phase A, Phase B, and Phase C and the G/F indicates ground fault. (Display 4)
- When the motor reaches full speed, the “AUX4” LED (At Speed) will be lit.
- If the motor decelerates, or stops, during the acceleration period, hit the stop button immediately and open the disconnect line. If the unit does not follow this operational sequence, please refer to the Troubleshooting Chapter.

1	MOTOR STOPPED READY TO START
2	MOTOR STARTING 00 X FLA
3	OVERLOAD ALARM TIME TO TRIP: XXX SECS.
4	IA: IB: IC: G/F:

It is best to operate the motor at its full load starting condition to achieve the proper time, torque and ramp settings. Initial settings are set to accommodate most motor conditions. TRY INITIAL SETTINGS FIRST. See Setpoint Page 2 (Sect 5.1.2) to make any adjustments.

- Initial Voltage
- Soft Start Curve
- Current Limit
- Acceleration Time

If decel is enabled, the following parameters for Deceleration Time, Start Decel Voltage and Stop Decel Voltage (see SP2) must also be programmed. See Setpoint Page 2 (Sect 5.1.2) to make any adjustments.

Chapter 4 - User Interface & Menu Navigation

This chapter explains the keypad operator interface, the LCD descriptions and the programming features.

4.1 Keypad/Operator Interface

The user keypad/ operator interface consists of:

- 2 row by 20 characters Liquid Crystal Display (LCD)
- 12 LEDs
- 8 pushbuttons

Note: The DXT Series is menu driven and there are three levels of programming. The programming for two of these levels is password protected. Level two requires a three digit password and level three requires a four digit password.

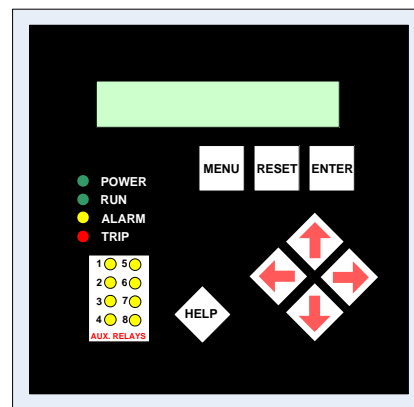

4.1.1. Keypad Operator designations and functions

ITEM	DESIGNATION	DESCRIPTION
KEY	MENU	Toggle between the menu selection for metering and set point pages.
	RESET	Will clear the trip indicator and release the trip relay.
	ENTER	When a set point page is active, pressing the ENTER button once enters the EDIT mode. In this mode set point values can be changed. An "Asterisk" appears on the display to indicate edit mode is active. After a set point value is changed, pressing the ENTER button again will save the revised value to memory and the asterisk will go away indicating the change has been saved. When edit mode is not active, the ENTER pushbutton will toggle through the event indicator list (such as alarms or trips).
	HELP	Provides general help information about a specific set point or action.
	UP ARROW	Will scroll up through the set point and metering menu page. It will scroll to the top of the set point page or a section. In edit mode it will increase a set point in an incremental step or toggle through the available options in the set point.
	RIGHT ARROW	In the main menu the RIGHT ARROW button provides access to the set point page. For set point pages with multiple columns, the RIGHT ARROW will scroll the set point page to the right. When in edit mode it will shift one character to the right.
	DOWN ARROW	Will scroll down through the set point pages and down through the set points. In edit mode, it will decrement through values and toggle available options in the set point.
	LEFT ARROW	Will move to the left through set point pages with multiple columns. When in edit mode it will become the backspace key and will shift one character to the left.
LED	POWER	Indicates control power is present
	RUN	Indicates unit/motor is running
	ALARM	Lights in conjunction with Relay AUX 2 to indicate an Alarm event or warn of possible critical condition.
	TRIP	Lights in conjunction with Relay AUX 1 to indicate a Trip condition has occurred.
	AUX 1 - 4	Auxiliary relays

Note: The directional arrow buttons require careful operation. In edit mode, if the buttons are held for a long period, the scrolling speed will increase.

4.2 Menu Navigation

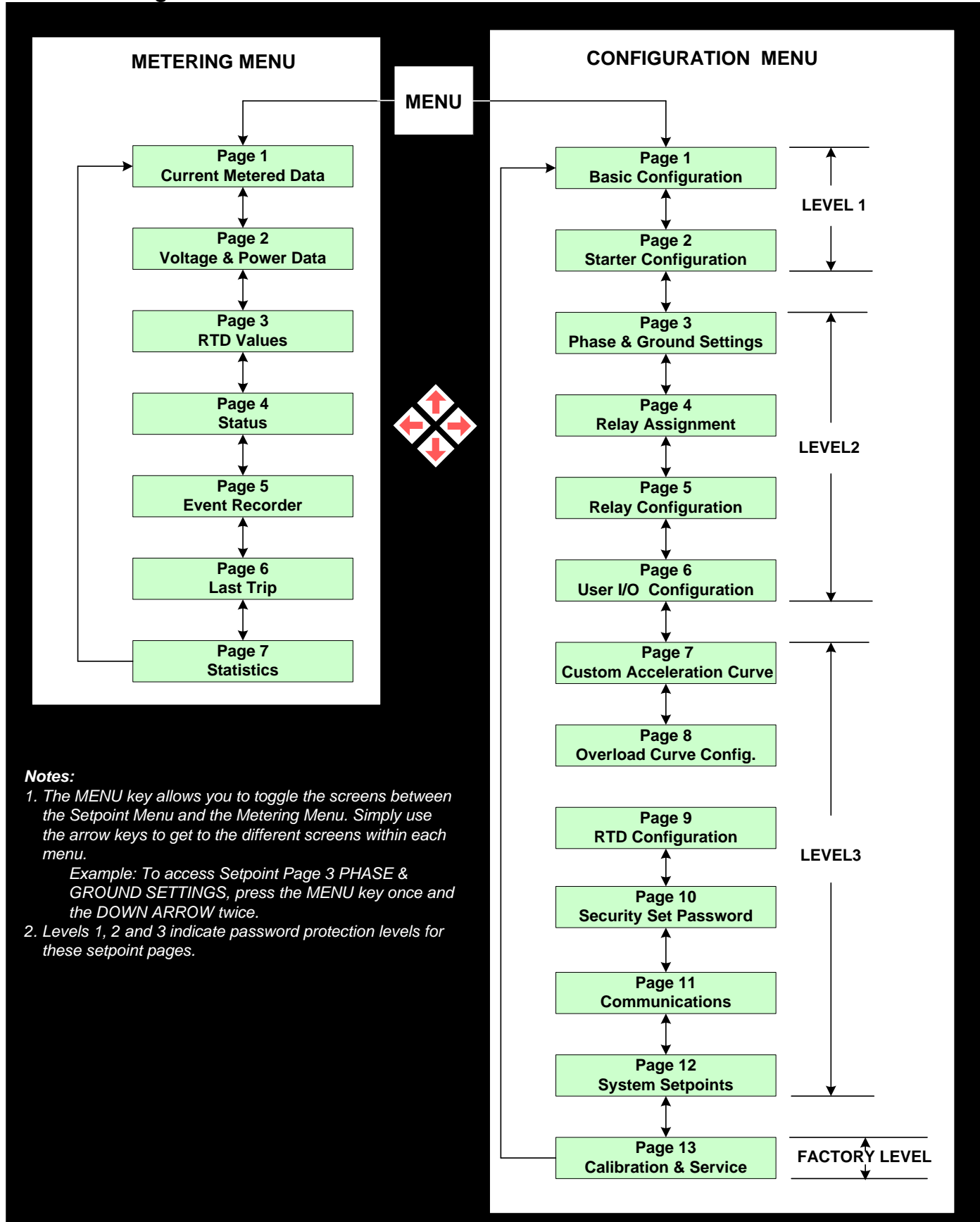

Notes:

1. The MENU key allows you to toggle the screens between the Setpoint Menu and the Metering Menu. Simply use the arrow keys to get to the different screens within each menu.

Example: To access Setpoint Page 3 PHASE & GROUND SETTINGS, press the MENU key once and the DOWN ARROW twice.

2. Levels 1, 2 and 3 indicate password protection levels for these setpoint pages.

4.2.1 Password Access

Screens in Level 1 of the set point menu can be changed without password access because they list basic motor information. Screens in Levels 2 and 3 require passwords because they provide more in-depth protection and control of the unit. The password in Levels 2 and 3 can be changed / set by the user.

Note: Set Points can only be changed when the motor is in Stop/ Ready Mode! The DXT Series will not allow a start if it is still in the Edit Mode. When the unit is in the Edit Mode, an asterisk is displayed in the top right corner screen.

4.2.2 Changing Set Points

Example 1: Changing Motor FLA from 140 AMPS to 142 AMPS

1. Press MENU button to display Set point Page 1, Basic Configuration
2. Press the RIGHT ARROW you will view the screen Motor Full Load Amps.
3. Press the ENTER button for edit mode.
Note: The asterisk (*) in the top right corner of the LCD screen that indicates Edit Mode.
4. To change the value, select the UP ARROW or DOWN ARROW. In this case push the UP ARROW twice (2x).
5. To accept the new value, press the ENTER button. The unit will accept the changes and will leave the edit mode.
 Note the * is no longer in the top right corner of the LCD Display.

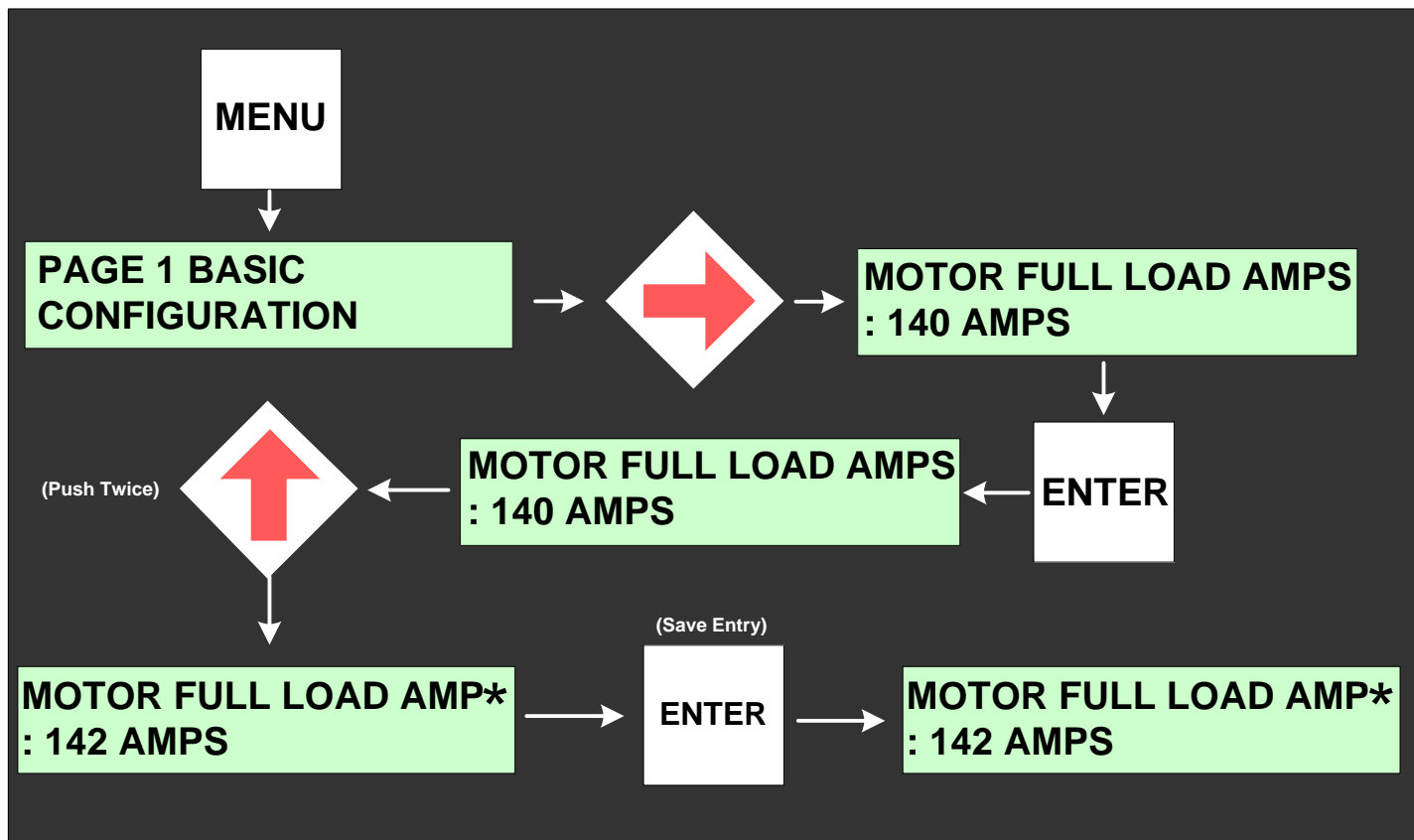

Chapter 5 - Setpoint Programming

The **DXT Series** has thirteen programmable Setpoint pages which define the motor data, ramp curves, protection, I/O configuration and communications. In Section 5.1, the Setpoint pages are outlined in chart form. In Section 5.2 the Setpoint pages are illustrated and defined for easy navigation and programming. **Note:** Setpoints can only be changed when the starter is in the Ready Mode. Also the soft start will not start when it is in programming mode.

5.1 Setpoints Page List

These charts list the Setpoint Page, programmable functions and the section. (See 5.2 Setpoints menu)

5.1.1 Basic Configuration (Setpoint Page 1)

Setpoint Page	Security Level	Description	Factory Setting Default	Range	Section
Page 1 Basic Configuration	Level 1 No Password Required	Motor Full Load Amps (FLA)	Model dependent	50 - 100% of Unit Max Current Rating (Model and Service Factor dependent)	SP1.1
		Service Factor	1.15	1.00 – 1.3	SP1.2
		Overload Class	10	O/L Class 5-30	SP1.3
		NEMA Design	B	A-F	SP1.4
		Insulation Class	B	A, B, C, E, F, H, K, N, S	SP1.5
		Line Voltage	480	208 to 600V	SP1.6
		Line Frequency	60	50 or 60 HZ	SP1.7

5.1.2 Starter Configuration (Setpoint Page 2)

Setpoint Page	Security Level	Description	Factory Setting Default	Range	Section
Page 2 Starter Configuration	Level 1 No Password Required	Start Control Mode	Start Ramp 1	Jog, Start Ramp 1, Start Ramp 2, Custom Accel Curve, Start Disabled, Dual Ramp, Tach Ramp	SP2.1
		Jog Voltage	50%	5-75%, Off	SP2.2
		Start Ramp #1 Type	Voltage	Voltage, Current	SP2.3
		Initial Voltage #1	20%	0-100%	
		Ramp Time #1	10 sec	1-120 sec	
		Current Limit #1	350% FLA	200-600 %	
		Initial Current #1	200% FLA	0-300 %	
		Ramp Time #1	10 sec	1-120 sec	
		Maximum Current #1	350% FLA	200-600 %	
		Start Ramp #2 Type	Disabled	Disabled, Voltage, Power	SP2.4
		Initial Voltage #2	60%	0-100 %	
		Ramp Time #2	10 sec	1-120 sec	
		Current Limit #2	350% FLA	200-600 %	
		Initial Power #2	20%	0-100 %	
		Ramp Time #2	10 sec	1-120 sec	
		Maximum Power #2	80%	0 – 300 %	
		Kick Start Type	Disabled	Voltage or Disabled	SP2.5
		Kick Start Voltage	65%	10-100 %	
		Kick Start Time	0.50 sec	0.10-2.00	
		Deceleration	Disabled	Enabled or Disabled	SP2.6
		Start Deceleration Voltage	60%	0-100 %	
		Stop Deceleration Voltage	30%	0-99 %	
		Deceleration Time	5 sec	1-60 sec	
Timed Output Time	Off	1-1000 sec, Off			
Run Delay Time	1 Sec	1-30 sec, Off	SP2.8		
At Speed Delay Time	1 Sec	1-30 sec, Off	SP2.9		
Bypass Pull-in Current	100% FLA	90 – 300%	SP2.10		

5.1.3 Phase and Ground Settings (Setpoint Page 3)

Setpoint Page	Security Level	Description	Factory Setting Default	Range	Section
Page 3 Phase and Ground Settings	Level 2 Password Protected	Imbalance Alarm Level	15% FLA	5-30 %, Off	SP3.1
		Imbalance Alarm Delay	1.5 sec	1.0-20.0 sec	
		Imbalance Trip Level	20%	5-30 %, Off	SP3.2
		Imbalance Trip Delay	2.0 sec	1.0-20.0 sec	
		Undercurrent Alarm Level	Off	10-90 %, Off	SP3.3
		Undercurrent Alarm Delay	2.0 sec	1.0-60.0 sec	
		Overcurrent Alarm Level	Off	100-300 %, Off	SP3.4
		Overcurrent Alarm Delay	2.0 sec	1.0-20.0 sec	
		Overcurrent Trip Level	Off	100-300 %, Off	SP3.5
		Overcurrent Trip Delay	2.0 sec	1.0-20.0 sec	
		Phase Loss Trip	Enabled	Enabled or Disabled	SP3.6
		Phase Loss Trip Delay	0.1 sec	0-20.0 sec	
		Phase Rotation Detection	ABC	ABC, ACB or Disabled	SP3.7
		Phase Rotation Trip Delay	1.0 sec	1.0 - 20.0 sec	
		*Ground Fault Alarm Level	Off	5-90 %, Off	SP3.8
		*Ground Fault Alarm Delay	0.1 sec	0.1-20.0 sec	
		*Ground Fault Lo Set Trip Level	Off	5-90 %, Off	SP3.9
		*Ground Fault Lo Set Trip Delay	0.5 sec	0.1-20 sec	
		*Ground Fault Hi Set Trip Level	Off	5-90 %, Off	SP3.10
		*Ground Fault Hi Set Trip Delay	0.008 sec	0.008-0.250 sec	
		Overvoltage Alarm Level	Off	5 -30%, Off	SP3.11
		Overvoltage Alarm Delay	1.0 sec	1.0-30.0 sec	
		Overvoltage Trip Level	10%	5-30%, Off	SP3.12
		Overvoltage Trip Delay	2.0 sec	1.0-30.0 sec	
		Undervoltage Alarm Level	Off	5-30%, Off	SP3.13
		Undervoltage Alarm Delay	1.0 sec	1.0-30.0 sec	
		Undervoltage Trip Level	15%	5-30%, Off	SP3.14
		Undervoltage Trip Delay	2.0 sec	1.0-30.0 sec	
		Line Frequency Trip Window	Disabled	0-6 Hz, Disabled	SP3.15
		Line Frequency Trip Delay	1.0 sec	1.0-20.0 sec	
		P/F Lead Alarm	Off	0.1-1.00, Off	SP3.16
		P/F Lead Alarm Delay	1.0 sec	1-120 sec	
		P/F Lead Trip	Off	.01-1.00, Off	SP3.17
P/F Lead Trip Delay	1.0 sec	1-120 sec			
P/F Lag Alarm	Off	.01-1.00, Off	SP3.18		
P/F Lag Alarm Delay	1.0 sec	1-120 sec			
P/F Lag Trip	Off	.01-1.00, Off	SP3.19		
P/F Lag Trip Delay	1.0 sec	1-120 sec			
Power Demand Period	10 min	1 - 60 min	SP3.20		
KW Demand Alarm Pickup	Off KW	Off, 1-100000			
KVA Demand Alarm Pickup	Off KVA	Off, 1-100000			
KVAR Demand Alarm Pickup	Off KVAR	Off, 1-100000			
Amps Demand Alarm Pickup	Off Amps	Off, 1-100000			

* Ground fault option must be installed

5.1.4 Relay Assignments (Setpoint Page 4)

Setpoint Page	Security Level	Description	Range		Section	
			1st			
Page 4 Relay Assignments	Level 2 Password Protected	O/L Trip	TRIP ONLY		NONE TRIP (AUX1) / TRIP ONLY ALARM (AUX2) AUX3 AUX4	SP4.1
		I/B Trip	TRIP (AUX1)			
		S/C Trip	TRIP ONLY			
		Overcurrent Trip	TRIP (AUX1)			
		Stator RTD Trip	TRIP (AUX1)			
		Non Stator RTD Trip	TRIP (AUX1)			
		*G/F Hi Set Trip	TRIP (AUX1)			
		*G/F Lo Set Trip	TRIP (AUX1)			
		Phase Loss Trip	TRIP (AUX1)			
		Accel. Time Trip	TRIP ONLY			
		Start Curve Trip	TRIP ONLY			
		Over Frequency Trip	TRIP (AUX1)			
		Under Frequency Trip	TRIP (AUX1)			
		I* ¹ *T Start Curve	TRIP (AUX1)			
		Learned Start Curve	TRIP (AUX1)			
		Phase Reversal	TRIP (AUX1)			
		Overvoltage Trip	TRIP (AUX1)			
		Undervoltage Trip	TRIP (AUX1)			
		Power Factor Trip	TRIP (AUX1)			
		Tach Accel Trip	TRIP (AUX1)			
		Inhibits Trip	TRIP (AUX1)			
		Shunt Trip	AUX3			
		Bypass Discrepancy	TRIP (AUX1)			
		Low Control Voltage	TRIP (AUX1)			
		External Input #1	NONE			
		External Input #2	NONE			
		Dual Ramp	NONE			
		Thermostat	TRIP (AUX1)			
		O/L Warning	ALARM (AUX2)			
		Overcurrent Alarm	ALARM (AUX2)			
		*Ground Fault Alarm	ALARM (AUX2)			
		Under Current Alarm	ALARM (AUX2)			
		Motor Running	AUX3			
		I/B Alarm	ALARM (AUX2)			
		Stator RTD Alarm	ALARM (AUX2)			
		Non-Stator RTD Alarm	ALARM (AUX2)			
		RTD Failure Alarm	ALARM (AUX2)			
		Self Test Fail	TRIP (AUX 1)			
		Thermal Register	ALARM (AUX2)			
		U/V Alarm	ALARM (AUX2)			
O/V Alarm	ALARM (AUX2)					
Power Factor Alarm	ALARM (AUX2)					
KW Demand Alarm	ALARM (AUX2)					
KVA Demand Alarm	ALARM (AUX2)					
KVAR Demand Alarm	ALARM (AUX2)					
Amps Demand Alarm	ALARM (AUX2)					
Timed Output	NONE					
Run Delay Time	NONE					
At Speed	AUX4					

* Ground fault option must be installed

5.1.5 Relay Configuration (Setpoint Page 5)

Setpoint Page	Security Level	Description	Factory Setting Default	Range	Section
Page 5 Relay Configuration	Level 2 Password Protected	Trip (AUX1) Fail-Safe	No	Yes or No	SP5.1
		Trip (AUX1) Relay Latched	Yes		SP5.2
		Alarm (AUX2) Fail-Safe	No		SP5.1
		Alarm (AUX2) Relay Latched	No		SP5.2
		AUX3 Relay Fail-Safe	No		SP5.1
		AUX3 Relay Latched	No		SP5.2
		AUX4 Relay Fail-Safe	No		SP5.1
		AUX4 Relay Latched	No		SP5.2

5.1.6 User I/O Configuration (Setpoint Page 6)

Setpoint Page	Security Level	Description	Factory Setting Default	Range	Section		
Page 6 User I/O Configuration	Level 2 Password Protected	Tachometer Scale Selection	Disabled	Enabled or Disabled	SP6.1		
		Manual Tach Scale 4.0 mA:	0 RPM	0 - 3600			
		Manual Tach Scale 20.0 mA:	2000 RPM	0 - 3600			
		Tach Accel Trip Mode Select	Disabled	Underspeed, Overspeed or Disabled	SP6.2		
		Tach Ramp Time	20 sec	1 - 120			
		Tach Underspeed Trip PT	1650 RPM	0 - 3600			
		Tach Overspeed Trip PT	1850 RPM	0 - 3600			
		Tach Accel Trip Delay	1 sec	1 - 60			
		Analog Output #1	RMS Current	Off, RPM 0-3600, Hottest Non-Stator RTD 0-200°C, Hottest Stator RTD 0 - 200°C, RMS Current 0 - 7500 A, % Motor Load 0 - 600% kW	SP6.3		
		Analog Output #1 4mA:	0	0-65535			
		Analog Output #1 20mA:	250	0-65535			
		Analog Output #2	% Motor Load	Same As Analog Input #1	SP6.4		
		Analog Output #2 4mA:	0	0-65535			
		Analog Output #2 20mA:	1000	0-65535			
		User Programmable External Inputs					
		External Input #1 Select	Disabled	Enabled or Disabled	SP6.5		
		External Input #1 Type	Normally Open	Normally Open or Closed			
		Name External Input #1		User Defined, up to 15 Characters			
		External Input #1 Delay	1 sec	0-60 sec			
		External Input #2 Select	Disabled	Enabled or Disabled			
		External Input #2 Type	Normally Open	Normally Open or Closed			
		External Input #2 Delay	0 sec	0-60 sec			
		Name External Input #2		User Defined, up to 15 Characters			
		Dual Ramp, Input #3 Select	Dual Ramp	Enabled, Disabled or Dual Ramp			
		Dual Ramp Type, Input #3	Normally Open	Normally Open or Closed			
		Dual Ramp Time Delay, Input #3	0 sec	0-60 sec			
		Name External, Input #3	DUAL RAMP	User Defined, up to 15 Characters			
		Thermostat, Input #4	Enabled	Enabled or Disabled			
Thermostat, Input #4	Normally Closed	Normally Open or Closed					
Thermostat Time Delay, Input #4	1 sec	0-60 sec					
Thermostat Type, Input #4	THERMOSTAT	User Defined, up to 15 Characters					

Note: Thermostat input #4 is factory wired and set. Do Not alter any settings associated with this input.

5.1.7 Custom Acceleration Curve (Setpoint Page 7)

Setpoint Page	Security Level	Description	Factory Setting Default	Range	Section	
Page 7 Custom Acceleration Curve	Level 3 Password Protected	Custom Accel Curve	Disabled	Disabled, Curve A, B, or C	SP7.1	
		Custom Curve A				
		Curve A Current Limit	350% FLA	200-500%		
		Curve A Voltage Level 1	25%	0-100%		
		Curve A Ramp Time 1	2 sec	1-60 sec		
		Curve A Voltage Level 2	30%	0-100%		
		Curve A Ramp Time 2	2 sec	1-60 sec		
		Curve A Voltage Level 3	37%	0-100%		
		Curve A Ramp Time 3	2 sec	1-60 sec		
		Curve A Voltage Level 4	45%	0-100%		
		Curve A Ramp Time 4	2 sec	1-60 sec		
		Curve A Voltage Level 5	55%	0-100%		
		Curve A Ramp Time 5	2 sec	1-60 sec		
		Curve A Voltage Level 6	67%	0-100%		
		Curve A Ramp Time 6	2 sec	1-60 sec		
		Curve A Voltage Level 7	82%	0-100%		
		Curve A Ramp Time 7	2 sec	1-60 sec		
		Curve A Voltage Level 8	100%	0-100%		
		Curve A Ramp Time 8	2 sec	1-60 sec		
		Custom Curve B				Same Programmable Data Points and Ranges as Custom Curve A
Custom Curve C			Same Programmable Data Points and Ranges as Custom Curve A			

5.1.8 Overload Curve Configuration (Setpoint Page 8)

Setpoint Page	Security Level	Description	Factory Setting Default	Range	Section	
Page 8 Overload Curve Configuration	Level 3 Password Protected	Basic Run Overload Curve			SP8.1	
		Run Curve Locked Rotor Time	O/L Class	1-30 sec, O/L Class		
		Run Locked Rotor Current	600% FLA	400-800%		
		Coast Down Timer	Disabled	1-60 Min, Disabled		
		Basic Start Overload Curve				SP8.2
		Start Curve Locked Rotor Time	O/L Class	1-30 sec, O/L Class		
		Start Locked Rotor Current	600% FLA	400-800%		
		Acceleration Time Limit	30 sec	1-300 sec, Disabled		
		Number of Starts Per Hour	Disabled	1-6, Disabled		
		Time Between Starts Time	5 min	1-60 Min, Disabled		
		Area Under Curve Protection	Disabled	Enabled or Disabled		SP8.3
		Max I*I*T Start	368	1-2500 FLA*FLA*sec		SP8.4
		Current Over Curve	Disabled	Disabled, Learn, Enabled		
		Learned Start Curve Bias	10%	5-40%		
		Time for Sampling	30 sec	1-300 sec		

5.1.9 RTD Option Configuration (Setpoint Page 9)

Setpoint Page	Security Level	Description	Factory Setting Default	Range	Section
Page 9 RTD Configuration	Level 3 Password Protected	Use NEMA Temp for RTD Values	Disabled	Enabled or Disabled	SP9.1
		# of RTD Used for Stator	4	0-6	SP9.2
		RTD Voting	Disabled	Enabled or Disabled	SP9.3
		Stator Phase A1 Type	Off	120 OHM NI, 100 OHM NI, 100 OHM PT, 10 OHM CU	SP9.4
		RTD #1 Description	STATOR PHAS A1	User defined, Up to 15 Characters	
		Stator Phase A1 Alarm Level	Off	0-240C (32-464F), Off	
		Stator Phase A1 Trip Level	Off	0-240C (32-464F), Off	
		Stator Phase A2 Type	Off	Same as Stator Phase A1	
		RTD #2 Description	STATOR PHAS A2	User defined, Up to 15 Characters	
		Stator Phase A2 Alarm	Off	0-240C (32-464F), Off	
		Stator Phase A2 Trip Level	Off	0-240C (32-464F), Off	
		Stator Phase B1 Type	Off	Same as Stator Phase A1	
		RTD #3 Description	STATOR PHAS B1	User defined, Up to 15 Characters	
		Stator Phase B1 Alarm Level	Off	0-240C (32-464F), Off	
		Stator Phase B1 Trip Level	Off	0-240C (32-464F), Off	
		Stator Phase B2 Type	Off	Same as Stator Phase A1	
		RTD #4 Description	STATOR PHAS B2	User defined, Up to 15 Characters	
		Stator Phase B2 Alarm Level	Off	0-240C (32-464F), Off	
		Stator Phase B2 Trip Level	Off	0-240C (32-464F), Off	
		Stator Phase C1 Type	Off	Same as Stator Phase A1	
		RTD #5 Description	STATOR PHAS C1	User defined, Up to 15 Characters	
		Stator Phase C1 Alarm Level	Off	0-240C (32-464F), Off	
		Stator Phase C1 Trip Level	Off	0-240C (32-464F), Off	
		Stator Phase C2 Type	Off	Same as Stator Phase A1	
		RTD #6 Description	STATOR PHAS C2	User defined, Up to 15 Characters	
		Stator Phase C2 Alarm Level	Off	0-240C (32-464F), Off	
		Stator Phase C2 Trip Level	Off	0-240C (32-464F), Off	
		End Bearing Type	Off	Same as Stator A1	
		RTD #7 Description	END BEARING	User defined, Up to 15 Characters	
		End Bearing Alarm Level	Off	0-240C (32-464F), Off	
		End Bearing Trip Level	Off	0-240C (32-464F), Off	
		Shaft Bearing Type	Off	Same as Stator Phase A1	
		RTD #8 Description	SHAFT BEARING	User defined, Up to 15 Characters	
		Shaft Bearing Alarm Level	Off	0-240C (32-464F), Off	
		Shaft Bearing Trip Level	Off	0-240C (32-464F), Off	
		RTD #9 Type	Off	Same as Stator Phase A1	
		RTD #9 Description	-	User defined, Up to 15 Characters	
		RTD #9 Alarm Level	Off	0-240C (32-464F), Off	
		RTD #9 Trip Level	Off	0-240C (32-464F), Off	
		RTD #10 Type	Off	Same as Stator Phase A1	
RTD #10 Description	-	User defined, Up to 15 Characters			
RTD #10 Alarm Level	Off	0-240C (32-464F), Off			
RTD #10 Trip Level	Off	0-240C (32-464F), Off			
RTD #11 Type	Off	Same as Stator Phase A1			
RTD #11 Description	-	User defined, Up to 15 Characters			
RTD #11 Alarm Level	Off	0-240C (32-464F), Off			
RTD #11 Trip Level	Off	0-240C (32-464F), Off			
RTD #12 Type	Off	Same as Stator Phase A1			
RTD #12 Description	-	User defined, Up to 15 Characters			
RTD #12 Alarm Level	Off	0-240C (32-464F), Off			
RTD #12 Trip Level	Off	0-240C (32-464F), Off			

5.1.10 Password Level Configuration (Setpoint Page10)

Setpoint Page	Security Level	Description	Factory Setting Default	Range	Section
Page 10 Password	Level 3 Password	Set Level 2 Password	100	000 – 999 Three Digits	SP10.1
		Set Level 3 Password	1000	0000 – 9999 Four Digits	SP10.2

5.1.11 Communications Configuration (Setpoint Page11)

Setpoint Page	Security Level	Description	Factory Setting Default	Range	Section
Page 11 Communications	Level 3 Password	Set Front Baud Rate	9.6 KB/sec	2.4, 4.8, 9.6, 19.2, 38.4 KB/sec	SP11.1
		Set Modbus Baud Rate	9.6 KB/sec	2.4, 4.8, 9.6, 19.2, 38.4 KB/sec	SP11.2
		Modbus Address Number	247	1 – 247	SP11.3
		Set Access Code	1	1 – 999	SP11.4
		Set Link Baud Rate	38.4 KB/sec	2.4, 4.8, 9.6, 19.2, 38.4 KB/sec	SP11.5
		Remote Start/Stop	Disabled	Enabled or Disabled	SP11.6

5.1.12 System (Setpoint Page 12)

Setpoint Page	Security Level	Description	Factory Setting Default	Range	Section
Page 12 System Setpoints	Level 3 Password Protected	Default Display Screen			SP12.1
		Metering Data Page #	1	Enter Metering Page (1-3)	
		Metering Data Screen #	1	Enter Metering Screen Page 1 (1-10) Page 2 (1-11) Page 3 (1 - 29) Page 4 (1 - 6)	
		Alarms			SP12.2
		RTD Failure Alarm	Disabled	Enabled or Disabled	
		Thermal Register Alarm	90%	Off, 40-95%	
		Thermal Alarm Delay	10 sec	1-20 sec	
		Thermal Register Setup Info			SP12.3
		Cold Stall Time	O/L Class	O/L Class (5-30) or 4-40 second time delay	
		Hot Stall Time	½ O/L Class	½ O/L Class, 4-40 sec	
		Stopped Cool Down Time	30 Min	10-300 Min	
		Runing Cool Down Time	15 Min	10-300 Min	
		Relay Measured Cool Rates	Disabled	Enabled or Disabled	
		Thermal Register Minimum	15%	10-50%	
		Motor Design Ambient Temp	40C	10-90C	
		Motor Design Run Temperature	80% Max	50-100% of Motor Stator Max Temp	
		Motor Stator Max Temp	INS CLS	INS CLS, 10-240 C	
		I/B Input to Thermal Register	Enabled	Enabled or Disabled	
		Use Calculated K or Assign	7	1-50, On	
		Press Enter to Clr Thermal Reg.			

5.1.13 Calibration and Service (Setpoint Page 13)

Setpoint Page	Security Level	Description	Factory Setting Default	Range	Section
Page 13 Calibration & Service	Factory Use Only	Set Date and Time (DDMMYY:HHMM)	FACTORY SET; ## / ## / ## ## : ##		SP13.1
		Enter Date (DDMMYYYY)	FACTORY SET; ## / ## / #####	D=1-31, M=1-12, Y=1970-2069	
		Enter Time (HH:MM)	FACTORY SET; ## : ##	H=00-23, M=0-59	
		Model # Firmware REV. #	FACTORY SET; #####	Display Only, Cannot be changed	SP13.2
		Press Enter to Access Factory Settings		Available to Qualified Factory Personnel	SP13.3

5.2 Setpoints Menu and Parameter Explanation (SP1 – SP13)

SP.1 Basic Configuration (Setpoint Page 1)

In Setpoint Page 1, is used to setup basic nameplate data of the motor.

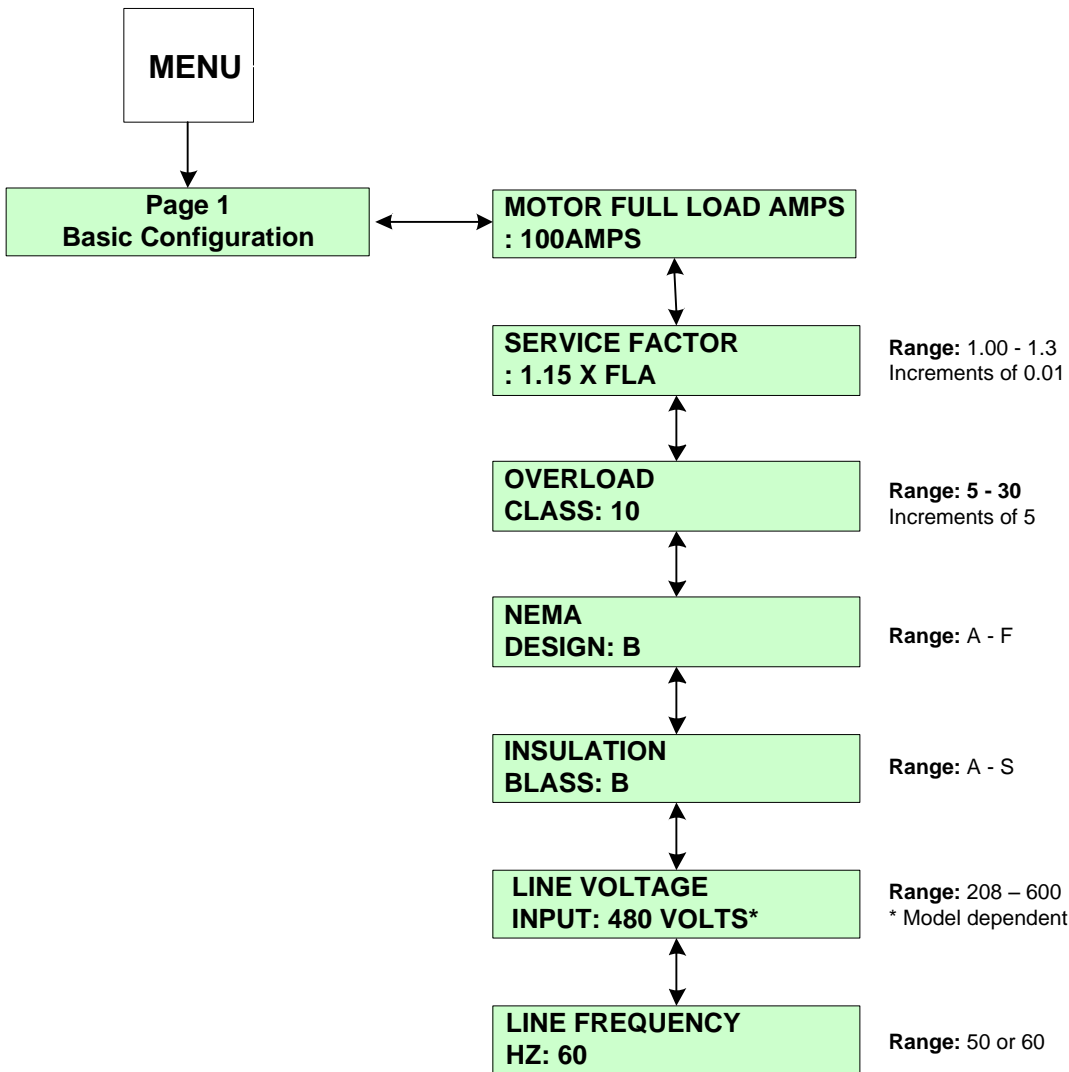

SP1.1 Motor Full Load Amps (FLA): Allows the user to enter the motor’s FLA rating. Range of adjustment is 50 - 100% of units maximum current rating (described below).

SP1.2 Service Factor: Sets the pickup point on the overload curve as defined by the programmed motor full load current. Ex: If the motor FLA is 100 and the service factor is 1.15, the overload pickup point will be 115 Amps.

SP1.3 Overload Class: Choose the motor protection overload class, range from 5-30. Ex: Overload Class 10 will trip in 10 seconds at six times the programmed motor FLA.

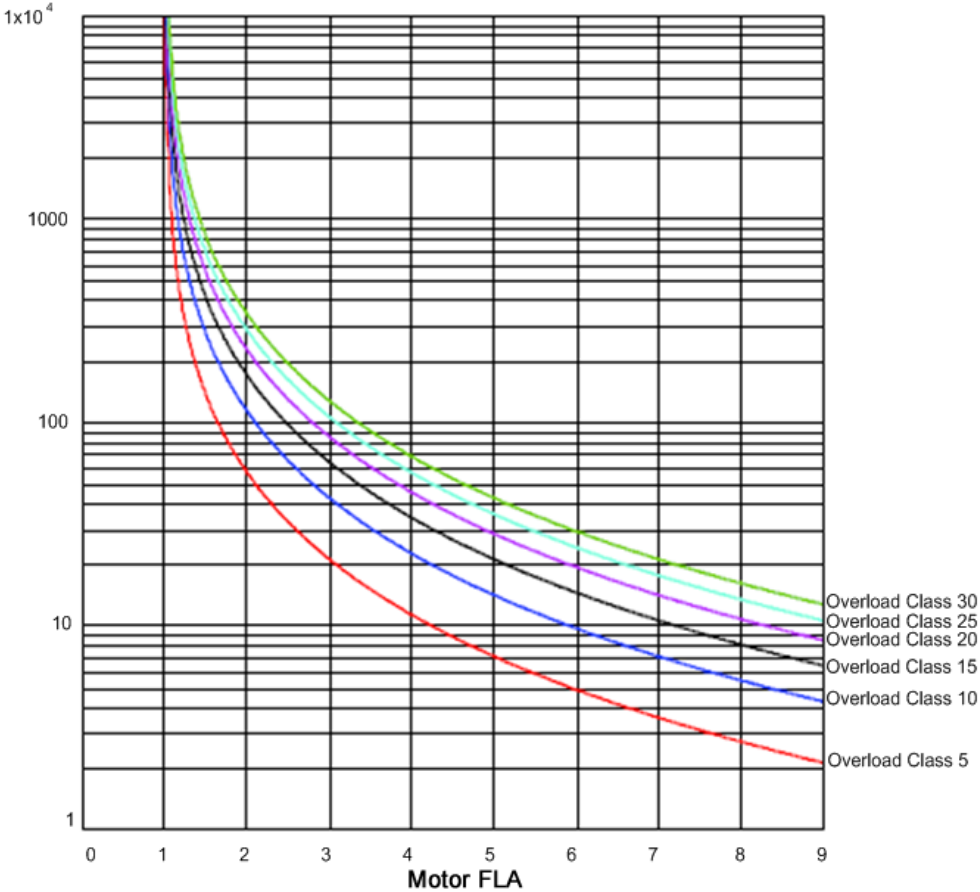

SP1.4 NEMA design: The motor design maximum allowed slip (Select from Class A through F).

SP1.5 Insulation Class: The motor insulation temperature class (Select A, B, C, E, F, G, H, K, N or S).

SP1.6 Line Voltage Input: Applied Voltage.

SP1.7 Line Frequency: The user may choose either 50 Hz or 60 Hz.

SP.2 Starter Configuration (Setpoint Page 2)

Provides multiple choices for starting ramps that can be selected for particular loads and applications.

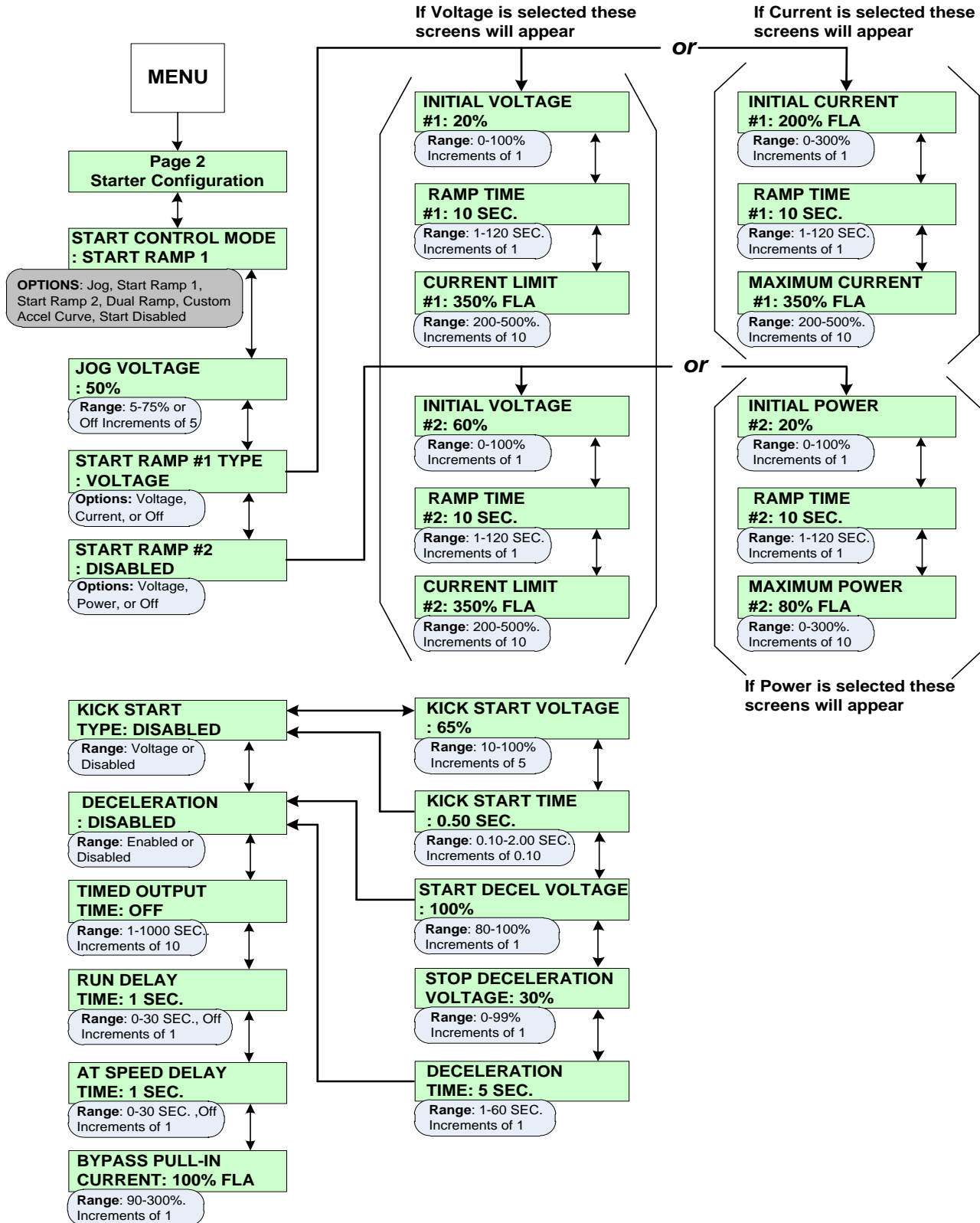

SP2 Starter Configuration (Setpoint Page 2) Menu Navigation

SP2.1 Start Control Mode: Dual Ramp, Custom Accel Curve, Jog Voltage, Start Ramp 1, Start Ramp 2.

- **Dual Ramp:** The dual ramp mode works in conjunction with External Input #3. This allows the user to switch between the two start ramps without having to reconfigure the start mode. (For details on configuring External Input #3 for DUAL RAMP see Setpoint **Page 6**.)

- **Custom Accel Curve:** Allows the user to custom design the acceleration start curve to the application. (See Setpoint page 7 for configuration setup.)

Note: If Custom Accel Curve has not been enabled in Setpoint page 7, the DXT Series will ignore the start control mode and read this Setpoint as disabled.

SP2.2 Jog Voltage: The voltage level necessary to cause the motor to slowly rotate.

SP2.3 Start Ramp 1 Type: The ramp type can be setup for either Voltage or Current. If Voltage is selected, initial voltage, ramp time and current limit are adjustable. If Current is selected, initial current, ramp time and maximum current are adjustable.

Start Ramp 1 Type: Voltage

- **Voltage Ramping** is the most reliable starting method because the starter will eventually reach an output voltage high enough to draw full current and develop full torque. This method is useful for applications where the load conditions change frequently and where different levels of torque are required. Typical applications include material handling conveyors, positive displacement pumps and drum mixers. Voltage is increased from a starting point, (Initial Torque) to full voltage over an adjustable period of time (Ramp Time). To achieve Voltage Ramping, select VOLTAGE for the START RAMP #1 TYPE Setpoint and set CURRENT LIMIT #1 Setpoint to 600% (the maximum setting). Since this is essentially Locked Rotor Current on most motors, there is little or no Current Limit effect on the Ramp profile.

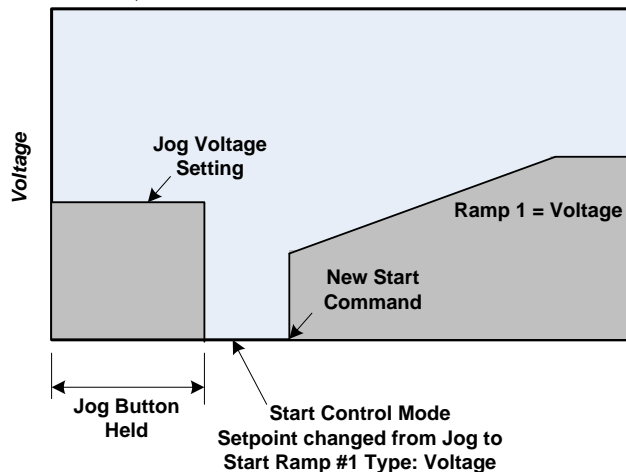

FIG. SP2.3 Example of Switching from Jog to Start Ramp #1 Type: Voltage

- **Voltage Ramping with Current Limit** is the most used curve and is similar to voltage ramping however, it adds an adjustable maximum current output. Voltage is increased gradually until the setting of the Maximum Current Limit Setpoint is reached. The output is held at this level until the motor accelerates to full speed. This may be necessary in applications where the electrical power is limited. Typical applications include portable or emergency generator supplies, utility power near the end of a transmission line and utility starting power demand restrictions.

Note: Using Current Limit will override the Ramp Time setting if necessary, so use this feature when acceleration time is not critical.

To set Voltage Ramping with Current Limit, select VOLTAGE for the START RAMP #1 Setpoint and set CURRENT LIMIT #1 Setpoint to a desired lower setting, as determined by your application requirements.

Start Ramp 1 Type: Current

- **Current Ramping** (Closed Loop Torque Ramping)

This method is used for smooth linear increase of output torque. This ramp is only used on some conveyor systems (long haul or down hill). For other applications, use Voltage Ramp or a custom Accel curve. Output voltage is constantly updated to provide the linear current ramp, and therefore the available torque is maximized at any given speed. This is for applications where rapid changes in torque may result in load damage or equipment changes. Typical applications include overland conveyors if belt stretching occurs; fans and mixers if blade warping is a problem; and material handling systems if stacked products fall over or break.

This feature can be used with or without the Maximum Current Limit setting. To achieve Current Ramping select CURRENT for START RAMP #1 TYPE Setpoint and set the MAXIMUM CURRENT #1 Setpoint to the desired level.

- **Current Limit Only** (Current Step) uses the Current Limit feature exclusively.

This method of starting eliminates the Soft Start voltage/current ramp and instead, maximizes the effective application of motor torque within the limits of the motor. In this mode, Setpoint RAMP TIME #1 is set to minimum so that the output current jumps to the current limit setting immediately. Typically used with a limited power supply when starting a difficult load such as a centrifuge or a deep well pump, when the motor capacity is barely adequate (stall condition or overloading occurs) or if other starting modes fail. Since ramp times are set to minimum, START RAMP #1 TYPE is set to either VOLTAGE or CURRENT.

- **Initial Torque (Initial Voltage #1 or Initial Current #1)**

Sets the initial start point of either Voltage Ramp or the Current Ramp. Every load requires some amount of torque to start from a standstill. It is inefficient to begin ramping the motor from zero every time, since between zero and the WK2 break-away torque level, no work is being performed. The initial torque level should be set to provide enough torque to start rotating the motor shaft, enabling a Soft Start and preventing torque shock damage. Setting this start point too high will not damage the starter, but may reduce or eliminate the soft start effect.

- **Ramp Time #1**

Sets the maximum allowable time for ramping the initial voltage, current (torque) or power setting to either of the following:

- The Current Limit setting when the motor is still accelerating.
- Full output voltage if the Current Limit is set to maximum.
- Maximum kW if Power Ramp is selected.

Increasing the ramp time softens the start process by gradually increasing the voltage, current or power. Ideally, the ramp time should be set for the longest amount of time the application will allow (without stalling the motor). Some applications require a short ramp time due to the mechanics of the system. (i.e. centrifugal pumps, because pump problems can occur due to insufficient torque).

- **Current Limit**

Sets the maximum motor current the starter will allow during the acceleration. As the motor begins to ramp, the Current Limit feature sets a maximum at which the current draw is held. Current Limit remains in effect until the following occurs:

- 1) The motor reaches full speed (Detected by the At-Speed detection circuit) or;
- 2) The Overload Protection trips on Motor Thermal Overload. Once the motor reaches full speed, the Current Limit feature becomes inactive. In the Voltage Ramp Profile, the voltage output is increased until it reaches the Current Limit. Ramp time is the maximum amount of time it takes for the voltage to increase until the Current Limit setting takes over. The Current Ramp profile varies the output voltage to provide a linear increase in current up to the Maximum Current Setpoint value. A closed loop feedback of motor current maintains the Current Ramp profile

SP2.4 Start Ramp 2 Type: Please refer to Ramp 1 settings for Ramp 2 Type: Voltage selection.

Start Ramp 2: Power

The **Power Ramp** feature has three programmable set points, Initial Power, Ramp Time and Maximum Power.

- The **Initial Power** set point allows the user to define an initial KW (motor power) value that will be applied to the motor when the start sequence is begun. It has a range of 0-100% and a default value of 20%.
- The **Ramp Time** set point functions as all other ramp time set points and allows the user to define a time period during which the applied KW (motor power) will be increased linearly to the Maximum Power value set point. The adjustment range is 1 to 120 seconds. Once the Power Limit value is reached, the system enters a constant power mode that regulates the applied motor power until the motor reaches full speed.
- The **Maximum Power** set point has an adjustment range of 0-300% and a default value of 80%.

 CAUTION
<p>It is recommended to use the power ramp on a loaded motor! Using the power ramp on an unloaded motor may result in shorter than anticipated acceleration times.</p>

Power Ramp Calculations: The default motor power value is derived from the line voltage and programmed FLA, using a unity power factor. This allows for approximation of the motor power rating without any other input data. During the Power Ramp process, the RMS line voltage, RMS motor current and power factor are measured on a cycle by cycle basis and applied to the Power Ramp algorithm. The CPU then calculates the True RMS motor power and will control the SCR firing to deliver the programmed power ramp values to the motor.

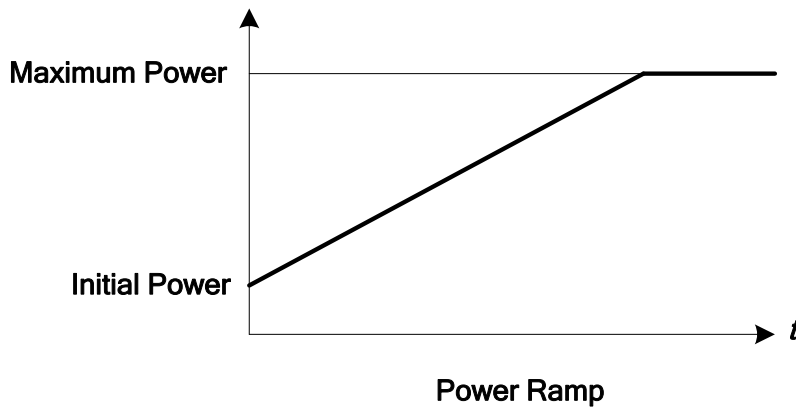

FIG. SP2.4

- **Initial Power:** The Initial power set point allows the user to define an initial KW (motor power) value that will be applied to the motor at the beginning of the start sequence.
- **Ramp Time #2:** See Ramp Time #1 for description
- **Maximum Power:** Sets the maximum motor power the starter will allow during the acceleration.

SP2.5 Kick Start: Used as an initial energy burst in applications with high friction loads.

- **Kick Start Voltage:** The initial voltage (as a percent of full voltage value) that is needed to start the motor. (i.e. Breakaway or Initial Torque.)
- **Kick Start Time:** The time the initial torque boost is applied.

SP2.6 Deceleration: Allows the motor to gradually come to a soft stop.

- **Start Deceleration Voltage:** Upon receiving a STOP command, the output voltage initially drops to this value to allow deceleration to begin. (Represented as a percent of voltage value.)
- **Stop Deceleration Voltage:** The drop-off point of the deceleration ramp. (Percent of voltage value.) The point at which the unit output drops to zero to end the deceleration.
- **Deceleration Time:** The time to get from the Start Deceleration to the stop Deceleration Voltage Set point value.

SP2.7 Timed Output: Used with an AUX relay. When enabled, and upon a start command, it waits until the programmed time plus the run delayed time has expired. The relay energizes and remains so until a stop command is received. It de-energizes upon receiving a stop command.

SP2.8 Run Delay Time: Can be used with an AUX relay. The delay timer begins upon receipt of the start command. The relay will then drop out when the time has expired.

SP2.9 At Speed Delay Time: Used with the AUX 4 relay, it energizes when the motor reaches At Speed and the programmed delay time has expired. The relay remains energized until a stop command has been received.

SP2.10 Bypass Pull-In Current

SP.3 Phase & Ground Settings
(Setpoint Page 3)
(Security Level 2)

SP3.1 Imbalance Alarm Level: This is an advance warning of a phase imbalance problem. The problem may not be a fault in the motor, but merely caused by imbalanced voltages.

- **Imbalance Alarm Delay:** The amount of time the imbalance condition must exist before an alarm occurs.

SP3.2 Imbalance Trip Level: This will trip the motor on excessive phase imbalance. The trip level should be programmed to a higher value than the alarm level.

- **Imbalance Trip Delay:** The amount of time the imbalance condition must exist before a trip will occur.

SP3.3 Undercurrent Alarm Level: Typically used to warn of possible load loss, a coupling break or other mechanical problems.

- **Undercurrent Alarm Delay:** The amount of time the undercurrent condition must exist before an alarm will occur.

SP3.4 Overcurrent Alarm Level: Typically used to indicate when the motor is overloaded. This feature can be used to either stop the feed to the equipment or warn operators of an overload condition.

- **Overcurrent Alarm Delay:** The amount of time the overcurrent condition must exist before an alarm will occur.

SP3.5 Overcurrent Trip Level: Typically used to indicate the motor is severely overloaded and at which point a trip occurs.

- **Overcurrent Trip Delay:** The amount of time the overcurrent condition must exist before a trip will occur.

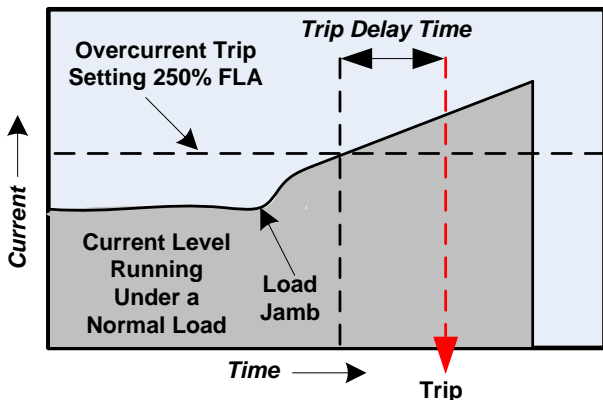
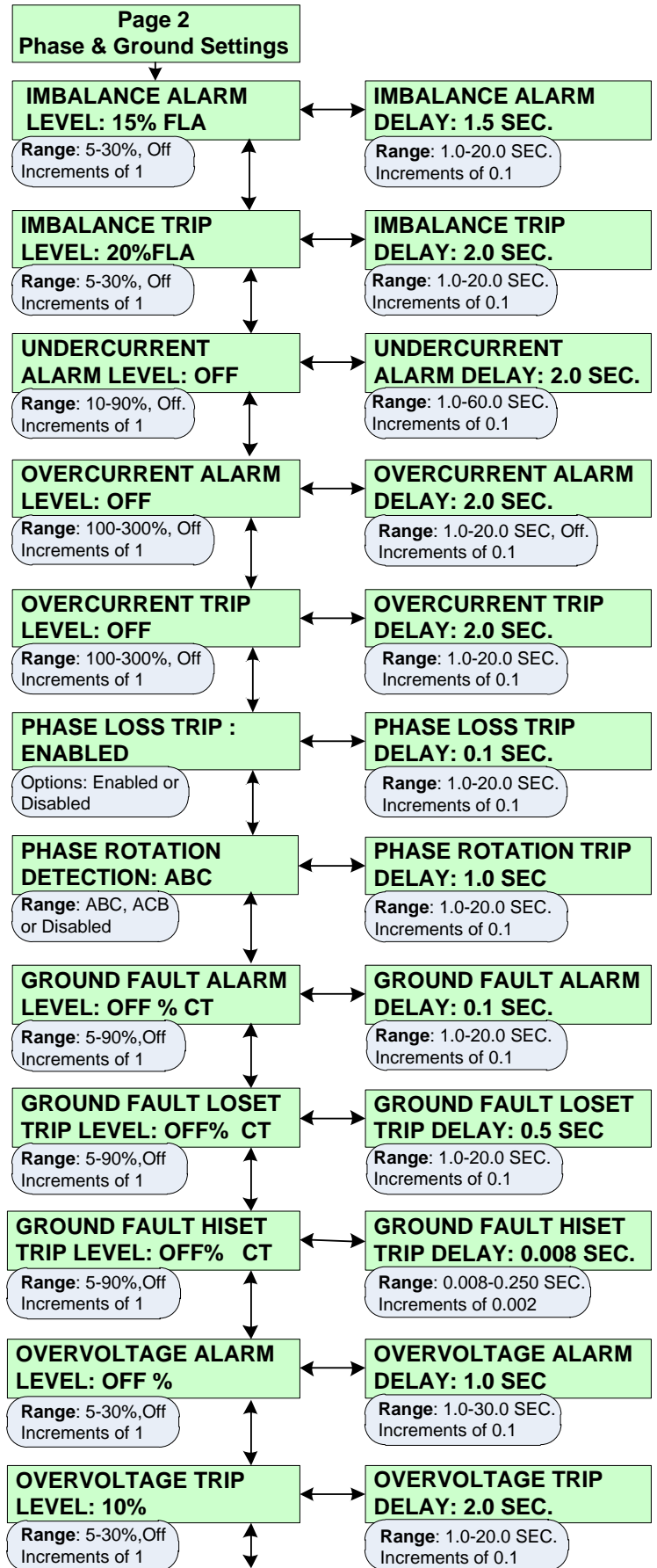

FIG. SP3.5



Continued (Next Page)

SP3.6 Phase Loss Trip: When enabled, the Soft Starter will trip the motor off-line upon a loss of phase power.

- **Phase Loss Trip Delay:** The amount of time the phase loss condition must exist before a trip will occur.

SP3.7 Phase Rotation Detection: The DXT Series monitors the phase rotation. A trip will occur if it detects a change in the phase rotation.

- **Phase Rotation:** There are two possible phase rotation options: ABC or ACB. This Setpoint monitors the wiring to ensure that the phase rotation is correct. To view the present phase rotation, go to Metering Page1, screen number 4.

- **Phase Rotation Trip Delay:** The amount of time the phase rotation condition must exist before a trip will occur.

SP3.8 *Ground Fault Alarm: Typically used to warn of low level ground current leakage

- **Ground Fault Alarm Delay:** The amount of time that the ground fault condition must exist before an alarm will occur.

SP3.9 *Ground Fault Lo Set Trip Level: Typically used to trip the motor on a low level of ground current leakage. This Setpoint is intended to detect high impedance faults.

- **Ground Fault Lo Set Trip Delay:** The amount of time that the ground fault condition must exist before a trip will occur.

* **Ground Fault Option must be installed**

SP3.10 *Ground Fault Hi Set Trip Level: Used to trip the motor (within milliseconds) upon detecting a high level of ground current leakage. This Setpoint is intended to detect low impedance faults.

- ***Ground Fault Hi Set Trip Delay:** The amount of time that the ground fault condition must exist before a trip will occur.

SP3.11 Overvoltage Alarm Level: Typically used to indicate when the line voltage is too high. This is an alarm level.

- **Overvoltage Alarm Delay:** The amount of time that the overvoltage condition must exist before an alarm occurs.

Continued (From Previous Page)

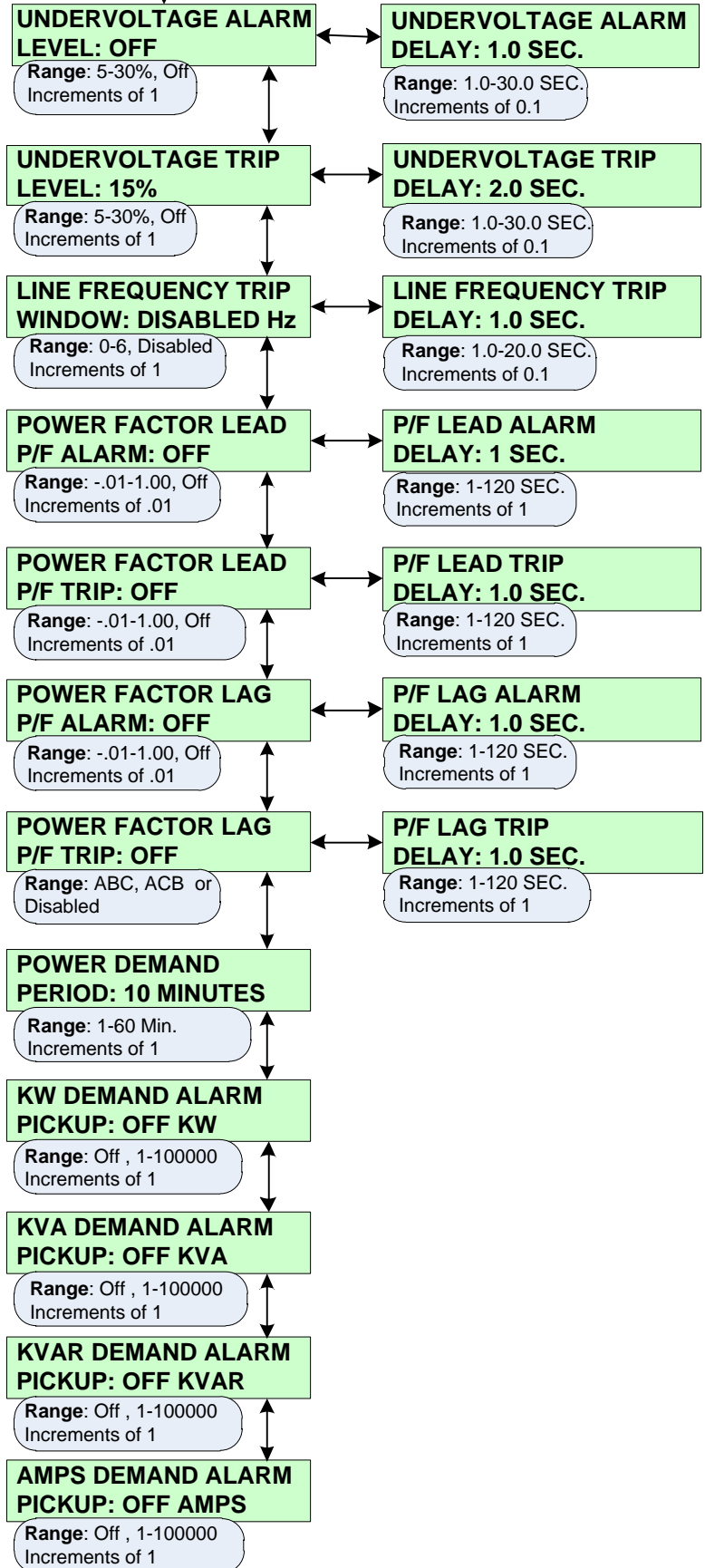

SP3.12 Overvoltage Trip Level: Typically used to indicate that the line voltage is too high and at which point a trip occurs

- **Overvoltage Trip Delay:** The amount of time that the overvoltage condition must exist before a trip will occur.

SP3.13 Undervoltage Alarm Level: Typically used to indicate when the line voltage is too low. This is an alarm level.

- **Undervoltage Alarm Delay:** The amount of time that the undervoltage condition must exist before an alarm occurs.

SP3.14 Undervoltage Trip Level: Typically used to indicate that the line voltage is too low at which point a trip occurs.

- **Undervoltage Trip Delay:** The amount of time that the undervoltage condition must exist before a trip occurs.

SP3.15 Line Frequency Trip Window: The acceptable amount of drift above or below the programmed line frequency (Hz) before a trip is generated.

- **Line Frequency Trip Delay:** The amount of time that the frequency drift condition must exist before a trip occurs.

SP3.16 Power Factor Lead Alarm: Typically used to indicate a leading power factor.

- **Power Factor Lead Alarm Delay:** The amount of time that the power factor lead condition must exist before an alarm occurs.

SP3.17 Power Factor Lead Trip: The unacceptable amount of leading power factor required to generate a trip..

- **Power Factor Lead Delay:** The amount of time the leading power factor lead condition must exist before a trip will occur.

SP3.18 Power Factor Lag Alarm: Typically used to indicate an excessively lagging power factor. (No load condition)

- **Power Factor Lag Alarm Delay:** The amount of time the lagging power factor condition must exist before an alarm occurs.

SP3.19 Power Factor Lag Trip: The unacceptable amount of lagging power factor required to generate a trip.

- **Power Factor Lag Delay:** The amount of time the lagging power factor condition must exist before a trip will occur.

SP3.20 Power Demand Period: The DXT Series monitors the demand of the motor based on several parameters (current, kW, kVAR, kVA). Monitoring the demand of the motor assist in the energy management program where processes can be altered or scheduled to reduce overall demand. Demand is calculated by taking samples of the output current, kW, kVAR and kVA over a period of time, then averaged and stored into memory.

SP.4 Relay Assignment (Setpoint Page 4) - (Security Level 2)

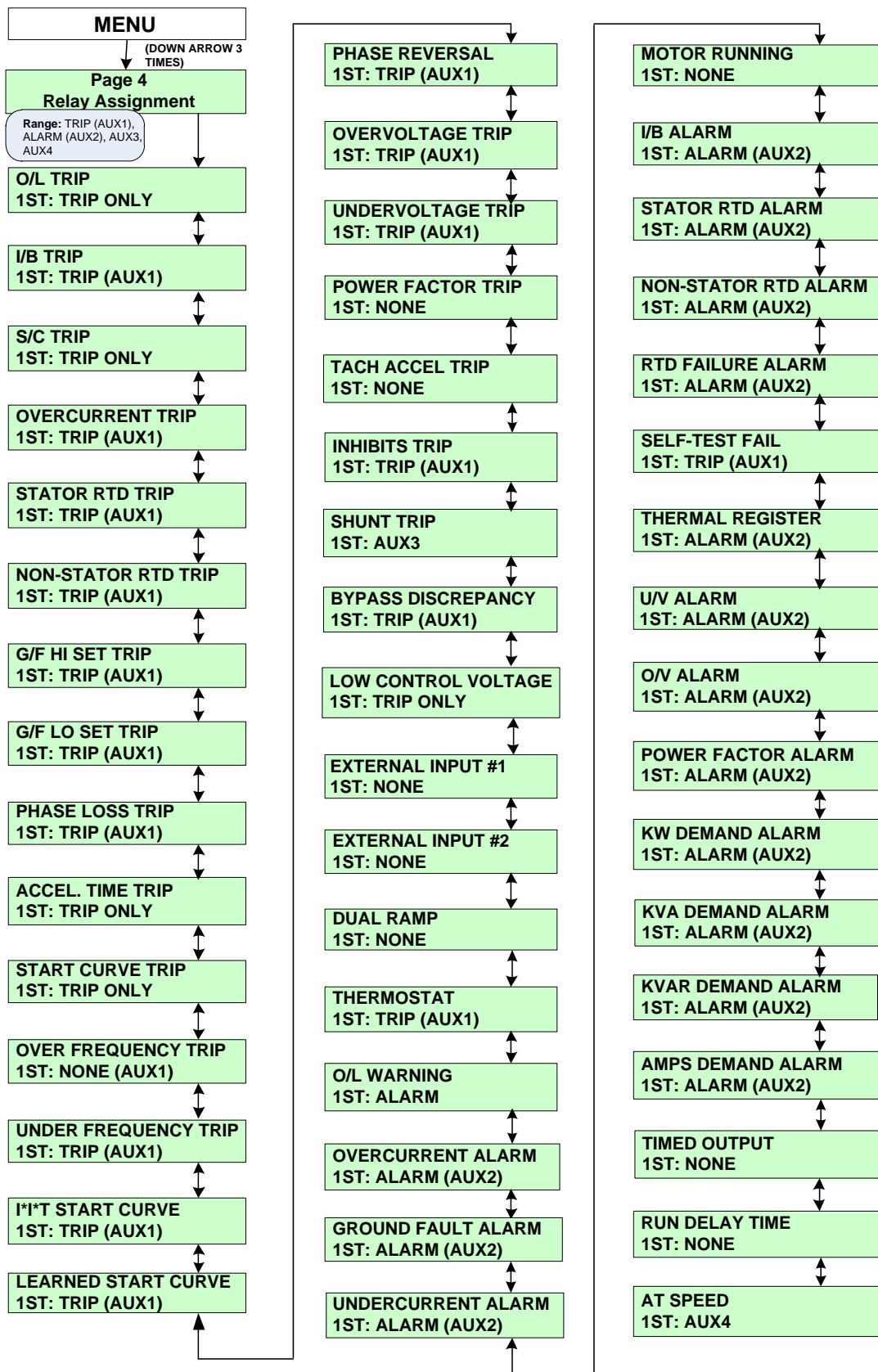

SP.4 Relay Assignment (Setpoint Page 4) - (Security Level 2) - Continued

All of the protective functions in DXT Series are user programmable to an output relay. The factory will ship with all tripping functions assigned to the TRIP (AUX1) relay, and all alarm functions to the ALARM (AUX2) relay.

Note: AUX1 - 4 are Factory Set. Care should be exercised if any relay assignments or functions are revised. Unless absolutely necessary they should not be changed.

SP4.1 The following is a list of all the user programmable functions.

Note: The Relay Assignments are factory defaults and should not be changed.

RELAY ASSIGNMENTS FUNCTIONS**Default Setting****1St**

	Default Setting
O/L Trip	TRIP ONLY
I/B Trip	TRIP (AUX1)
S/C Trip	TRIP ONLY
Overcurrent Trip	TRIP (AUX1)
Stator RTD Trip	TRIP (AUX1)
Non Stator RTD Trip	TRIP (AUX1)
*G/F Hi Set Trip	TRIP (AUX1)
*G/F Lo Set Trip	TRIP (AUX1)
Phase Loss Trip	TRIP (AUX1)
Accel. Time Trip	TRIP ONLY
Start Curve Trip	TRIP ONLY
Over Frequency Trip	TRIP (AUX1)
Under Frequency Trip	TRIP (AUX1)
I*I*T Start Curve	TRIP (AUX1)
Learned Start Curve	TRIP (AUX1)
Phase Reversal	TRIP (AUX1)
Overvoltage Trip	TRIP (AUX1)
Undervoltage Trip	TRIP (AUX1)
Power Factor Trip	TRIP (AUX1)
Tach Accel Trip	TRIP (AUX1)
Inhibits Trip	TRIP (AUX1)
Shunt Trip	AUX3
Bypass Discrepancy	TRIP (AUX1)
Low Control Voltage	TRIP (AUX1)
External Input #1	NONE
External Input #2	NONE
Dual Ramp	NONE
Thermostat	TRIP (AUX1)
O/L Warning	ALARM (AUX2)
Overcurrent Alarm	ALARM (AUX2)
*Ground Fault Alarm	ALARM (AUX2)
Under Current Alarm	ALARM (AUX2)
Motor Running	AUX3
I/B Alarm	ALARM (AUX2)
Stator RTD Alarm	ALARM (AUX2)
Non-Stator RTD Alarm	ALARM (AUX2)
RTD Failure Alarm	ALARM (AUX2)
Self Test Fail	TRIP (AUX 1)
Thermal Register	ALARM (AUX2)
U/V Alarm	ALARM (AUX2)
O/V Alarm	ALARM (AUX2)
Power Factor Alarm	ALARM (AUX2)
KW Demand Alarm	ALARM (AUX2)
KVA Demand Alarm	ALARM (AUX2)
KVAR Demand Alarm	ALARM (AUX2)
Amps Demand Alarm	ALARM (AUX2)
Timed Output	NONE
Run Delay Time	NONE
At Speed	AUX4

*Ground fault option must be installed

SP.5 Relay Configuration (Setpoint Page 5) - (Security Level 2)

In Setpoint Page 5 the user can configure the four output relays as either fail-safe or non-fail-safe and latching or non-latching.

SP5.1 When a relay has been configured for "Fail Safe" and power is applied to the unit the relay will energize and its contacts will change state. The relay will then de-energize and its contacts revert back when an event occurs or if power is removed.

NOTE: The relays in the DXT Series will not prevent a start sequence unless they are wired in as interlocks. If power is lost, the motor power is also lost. Care should be exercised if any relay assignments or functions are revised. Unless absolutely necessary they should not be changed.

SP5.2 A relay configured as non-latching will reset itself when the cause of the trip event is not continuous. The TRIP (AUX1) relay should always be programmed for latching, because this trip should require a visual inspection of the motor and starter before issuing a manual reset to release the relay after a trip has been stored.

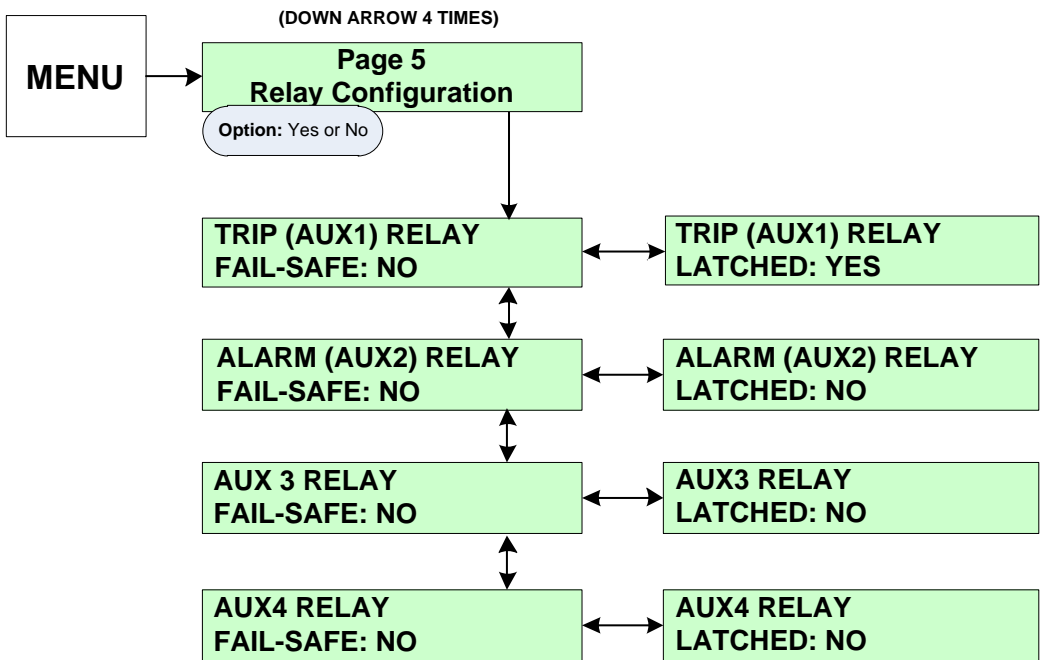

SP.6 User I/O Configuration (Setpoint Page 6) - (Security Level 2)

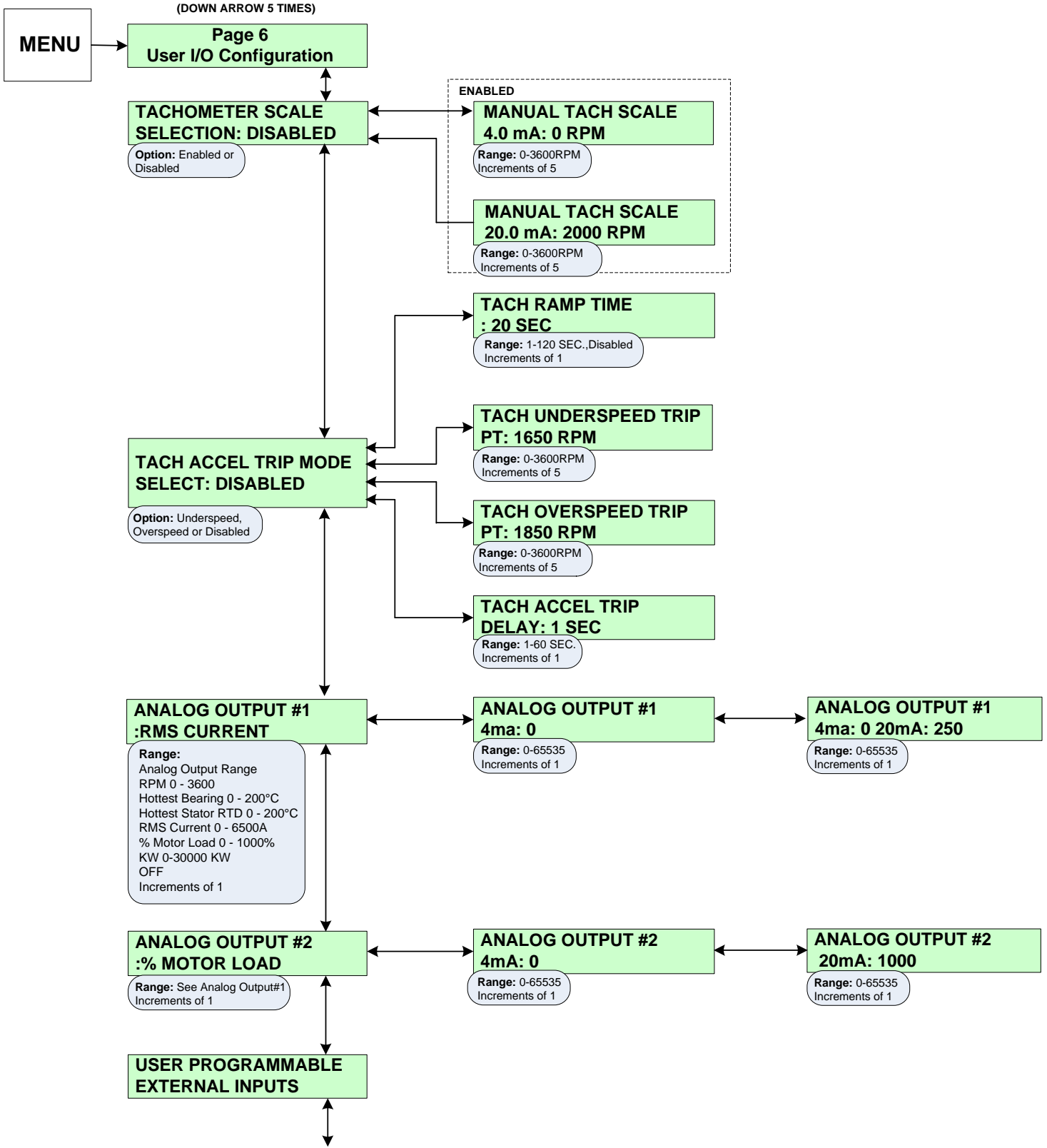

Continue on page 50.

SP.6 User I/O Configuration (Setpoint Page 6) - (Security Level 2) - Continued

The DXT Series can be configured to accept a tachometer feedback signal using the 4-20mA input.

SP6.1 The first screen of Setpoint page 6 is TACHOMETER SCALE SELECTION. When this is set to ENABLED, the user will need to input the tachometer scale of the 4-20mA input range.

- **Manual Tach Scale 4.0 mA:** The unit is looking for an RPM value to assign to the lowest point on the scale. This Value should represent the motor at zero speed.
- **Manual Tach Scale 20.0 mA:** The unit is looking for an RPM value to assign to the highest point on the scale. This value should represent the motor at full speed.

SP6.2 Tach Accel Trip Mode Select: When enabled, the underspeed or overspeed must be selected for the Tach Accel Trip. If underspeed is selected, only the Tach Underspeed Trip Point will be used. If overspeed is selected, only the Tach Overspeed Trip Point will be used.

- **Tach Ramp Time:** This is the duration of time before the starter begins sampling the tachometer.
- **Tach Underspeed Trip:** Defines the minimum running motor speed using the Tach feedback. When the underspeed trip mode is enabled and the motor speed falls below this level for the time specified by the Tach Accel Trip Delay an underspeed trip occurs.
- **Tach Overspeed Trip:** Defines the maximum allowed motor speed using the Tach feedback. When the overspeed trip mode is enabled and the motor speed exceeds this level for the time specified by the Tach Accel Trip Delay an overspeed trip occurs.
- **Tach Accel Trip Delay:** The duration of time that the Tach Accel trip condition must persist before a trip is generated.

SP6.3 The controller provides two 4-20mA analog outputs. Each analog output is independent of the other and can be assigned to monitor different functions. The available output ranges are; RPM, Hottest Non-Stator (Bearing) RTD, Hottest Stator RTD, RMS current, and % Motor Load.

- **Analog Output #1** – Select a function from the available five options to be transmitted from the 4-20mA output.

Note: *If selecting RPM, the Tachometer feedback input signal must be present in order for the controller to give proper output. If selecting RTD, the RTD option must be installed and an RTD input signal must be present for a proper output to be given from the analog output.*

- **Analog Output #1 (4 mA):** Enter a value that the 4mA level will represent for the selected function; typically this value should be 0.
- **Analog Output #1 (20 mA):** Enter a value that the 20mA level will represent for the selected function.

SP6.4 Analog Output #2 – All of the Setpoints and setup screens for Analog Output #2 are the same as those for Analog Output #1.

SP.6 User I/O Configuration (Setpoint Page 6) - (Security Level 2) – Continued

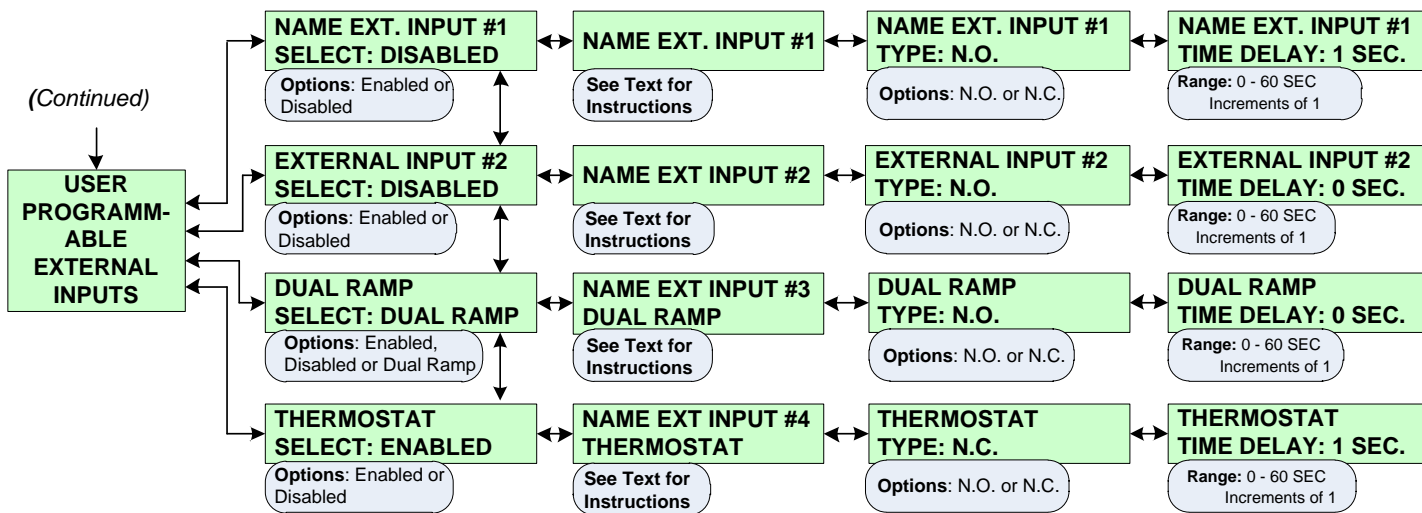

SP6.5 User Programmable External Inputs: The controller provides up to 4 digital external inputs which are individually programmable. A description name can be assigned to each individual input for easy identification.

- **External Input #1:** If used, this Setpoint must be enabled
 - **External Input #1 Type:** The external input can be set as either a normally open or normally closed contact.
 - **Name Ext. Input #1:** The user can assign a description name to the input to easily identify the cause of external trip or alarm. Up to 15 characters including spaces can be used to assign the name.
 - **External Input #1 Time Delay:** Upon a change in contact setting, the unit will wait the programmed amount of time before generating an output. If no delay is needed, then input 0 seconds. The controller will post an event upon seeing a change in state.
-
- **External Input #2:** If used, this Setpoint must be enabled.
 - **External Input #2 Type:** The external input can be set as either a normally open or normally closed contact.
 - **Name Ext. Input #2:** The user can assign a description name to the input to easily identify the cause of external trip or alarm. Up to 15 characters including spaces can be used to assign the name.
 - **External Input #2 Time Delay:** Upon a change in contact setting, the unit will wait the programmed amount of time before generating an output. If no delay is needed, then input 0 seconds. The controller will post an event upon seeing a change in state.

- **Dual Ramp (External Input #3):** The setup screens and setpoints for External Input #3 include the option of being configured for Dual Ramp. In Dual Ramp mode, the initial contact setting is the same as the START RAMP #1. Upon a change in input contact state, the **DXT** will switch over to START RAMP #2 and use that setting for start control mode. *Note:* The start RAMP types should only be switched while the motor is stopped. In Setpoint Page 4 Relay Assignments, do not assign any output relay to this function. The **DXT** will ship with External input #3 programmed for dual ramp. If it is not needed, disable the dual ramp.

Note: The start RAMP types should only be switched while the motor is stopped. In Setpoint Page 4 Relay Assignments do not assign any output relay to this function. The controller is programmed with External input #3 programmed for dual ramp. If it is not needed, disable the dual ramp.

- **Name Ext. Input #3:** The user can assign a description name to the input to easily identify the cause of external trip or alarm. Up to 15 characters including spaces can be used to assign the name.
- **External Input #3 Time Delay:** Upon a change in contact setting, the unit will wait the programmed amount of time before generating an output. If no delay is needed, then input 0 seconds. The controller will post an event upon seeing a change in state.
- **External Input #3 Type:** The external input can be set as either a normally open or normally closed contact.

Thermostat: Thermostat input #4 is factory wired and set. Do not alter any settings associated with this input. We recommend that this function remains enabled. If the thermostat indicates an over temperature condition, the **DXT** will trip the motor.

- **Name Ext. Input #4:** The user can assign a description name to the input to easily identify the cause of external trip or alarm. Up to 15 characters including spaces can be used to assign the name.
- **External Input #4 Time Delay:** Upon a change in contact setting, the unit will wait the programmed amount of time before generating an output. If no delay is needed, then input 0 seconds. The controller will post an event upon seeing a change in state.
- **External Input #4 Type:** The external input can be set as either a normally open or normally closed contact.

**SP.7 Custom Acceleration Curve
(Setpoint Page 7) - (Security Level 3)**

SP7.1 Setpoint Page 7 allows the user to custom design the acceleration curve (start curve) to the specific application. The user can custom design up to three different curves in the **DXT**. Only one curve can be active (enabled) at a time. Each of the three curves allow for eight voltage plotting points, with corresponding ramp times and a current limit setting.

Note: Each successive voltage level must be programmed to a voltage level equal to or greater than the previous level. All eight voltage levels must be programmed and the eighth level has been preset at 100%.

- If Custom Accel Curve has been set to curve A, B or C on this page, the **DXT** will override the Start Control Mode selected in Setpoint Page 2, (even if Start Control Mode in Setpoint Page 2 has not been set to Custom Accel Curve).

Note: Setpoint Page 7 has a security level 3 requirement.

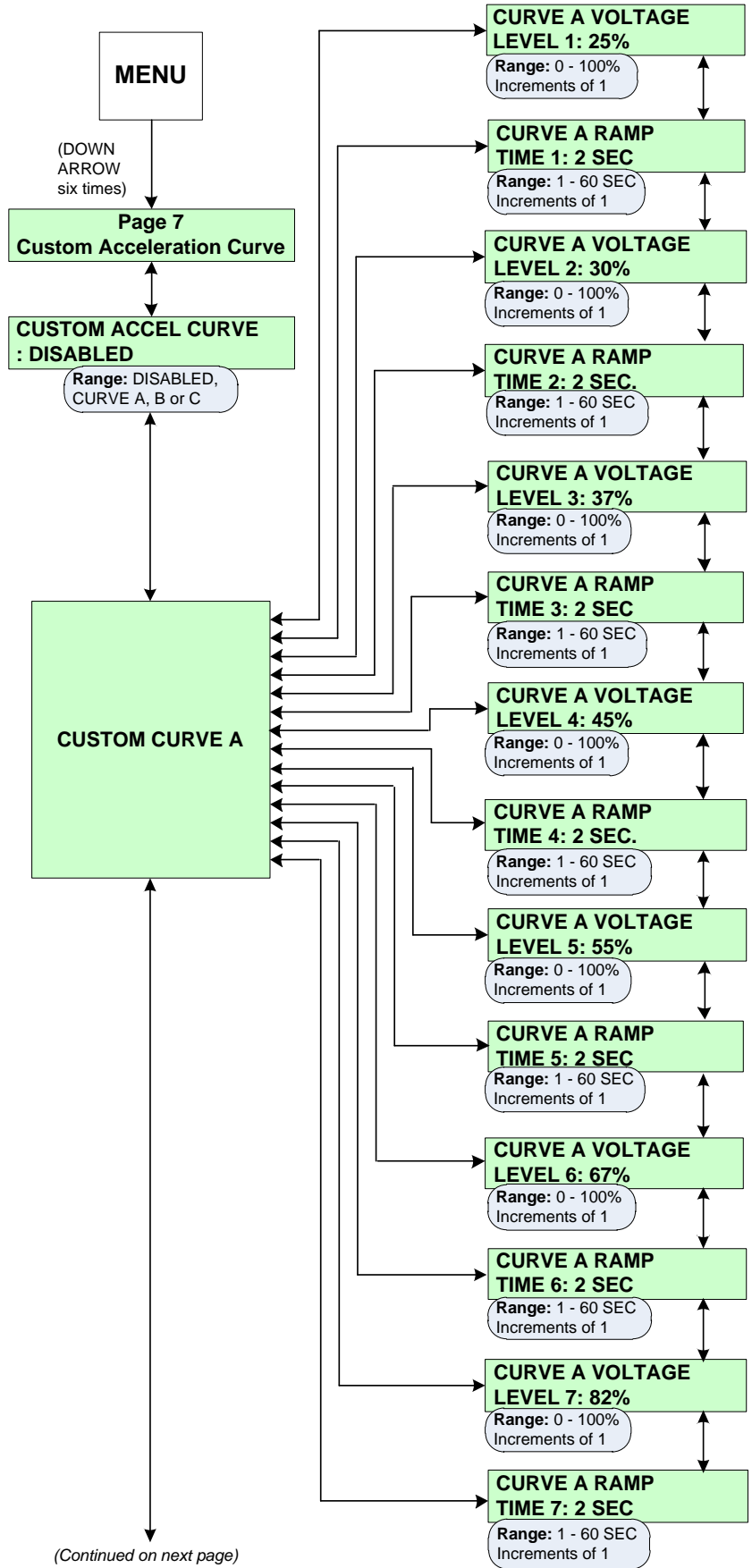

(Continued on next page)

SP.7 Custom Acceleration Curve (Setpoint Page 7) - (Security Level 3) - Continued

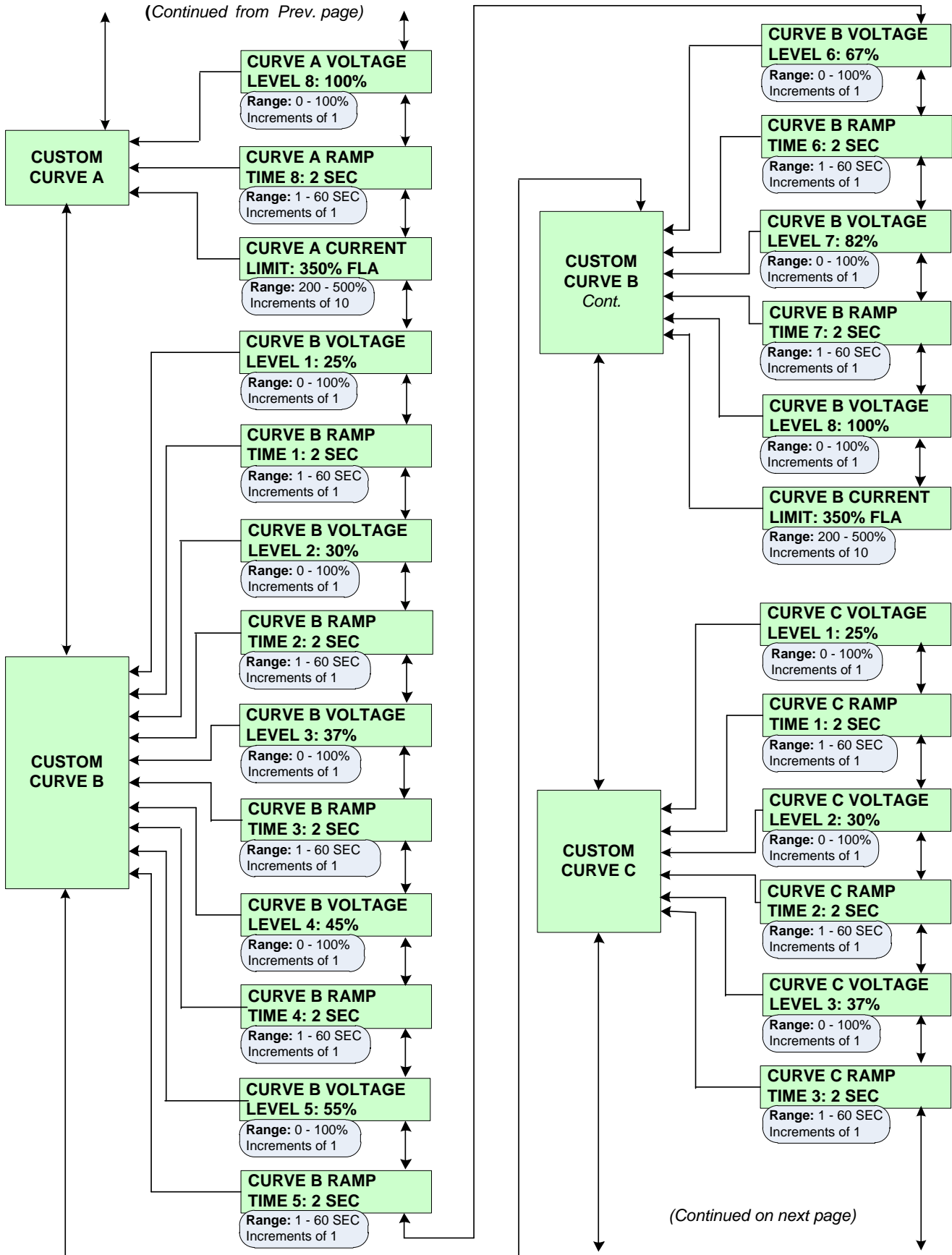

SP.7 Custom Acceleration Curve (Setpoint Page 7) - (Security Level 3) - Continued

(Continued from prev. page)

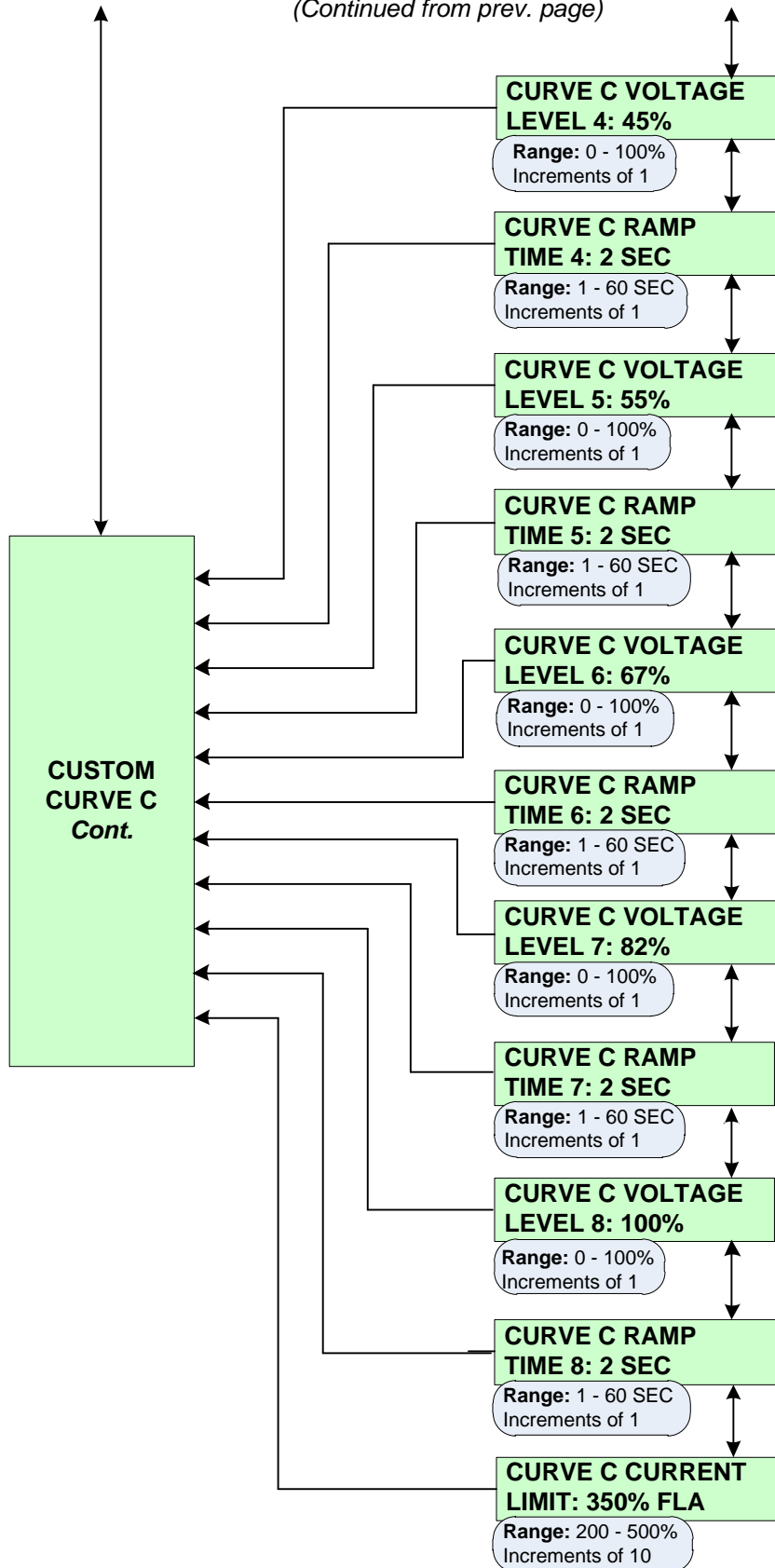

SP.8 Overload Curve Configuration (Setpoint Page 8) - (Security Level 3)

Configures the unit's start and run protection mode. The unit has independent start and run curve protection and the settings can be based on the OL Class or set by the motor's locked rotor current and time.

SP8.1 Basic Run Overload Curve

- **Run Curve Locked Rotor Time:** Set the locked rotor time to the OL Class default chosen in Setpoint Page 1 or set the time in seconds. This is the time the locked rotor condition exists before a trip occurs.
- **Run Locked Rotor Current:** The current the motor draws with full voltage on the windings and no rotor movement (as a percent of motor FLA). Refer to the nameplate data or contact the motor manufacturer.
- **Coast Down Timer:** If enabled, this prevents the motor from restarting for the programmed amount of time, after a stop command is given.

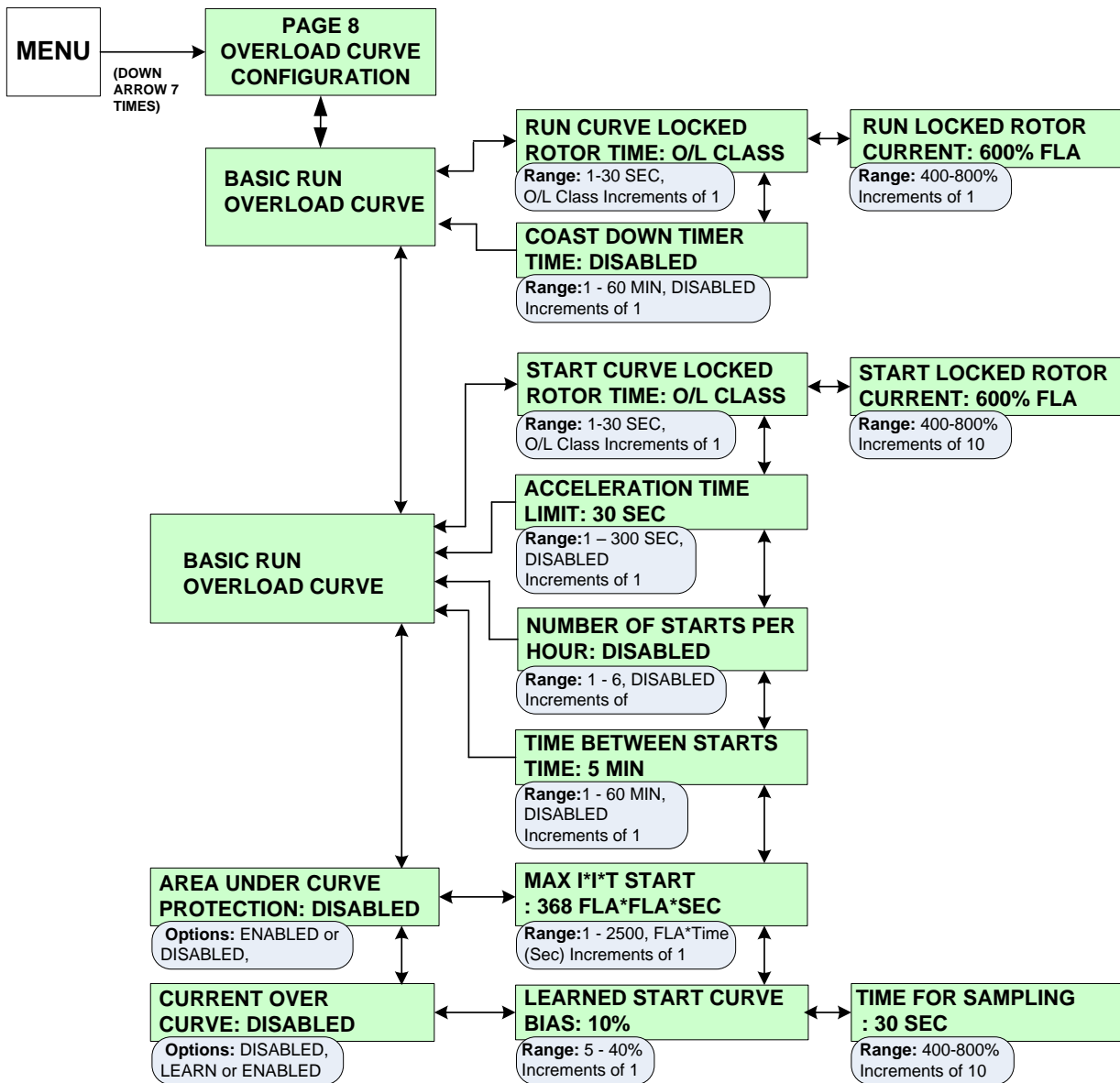

SP8.2 Basic Start Overload Curve

- **Start Curve Locked Rotor Time:** The locked rotor time can be set to the OL Class default chosen in Setpoint Page 1 or to a specific time. The overload condition must exist for the programmed amount of time before a trip occurs.
- **Start Locked Rotor Current:** The current the motor draws with full voltage on the windings and no motor movement (as a percent of motor FLA). Refer to the motor nameplate data or contact the motor manufacturer.
- **Acceleration Time Limit:** If the motor does not enter run mode (reach “at speed”) within the preset time, the unit trips on acceleration time limit.
- **Number of Starts per hour:** If enabled, this limits the maximum number of starts permitted per hour. This Setpoint allows a maximum of 6 starts per hour. Contact the motor manufacturer for further information regarding number of starts per hour.
- **Time Between Starts:** If enabled, the DXT Series prevents another start attempt until the programmed time has expired.

SP8.3 Area Under Curve Protection: If enabled, this secondary start protection uses both the basic start protection and the area under the curve protection.

- **Max I²t Start:** The maximum I²t allowed during start. If the I²t to start exceeds this number then the **DXT** will generate a trip.

SP8.4 Current Over Curve: Learns the motor’s starting characteristics and protects the motor based upon the learned curve. It is useful when commissioning a new motor.

- **Learn:** The unit reads the motor’s starting characteristics. Start the motor and allow it to come to full speed. The start feedback enables the motor protection based on the learned start curve.
- **Learned Start Curve Bias:** The maximum allowed deviation above or below the start curve before a trip is generated.
- **Time for sampling:** The time the DXT Series continues to sample the start curve characteristic during learn mode.

SP.9 RTD Option Configuration (Setpoint Page 9) - (Security Level 3)

Note: The RTD is an option. Contact factory for additional information.

The **DXT** is available with an optional RTD card that provides 12 programmable RTDs which are individually programmable for type. The available types are 100 ohm platinum, 100 ohm nickel, 120 ohm nickel and 10 ohm copper. Each RTD can be identified with a description name of up to 15 characters (including spacing). Also, each individual RTD has its own alarm and trip level.

SP9.1 Use NEMA Temp for RTD Value:

When this Setpoint is enabled, the **DXT** will use the NEMA design insulation class to limit the maximum allowed range of the alarm and trip level. The maximum allowed temperature range is 240° C or (464°F).

SP9.2 Number Of RTD'S Used for Stator:

Up to six RTDs can be assigned to monitor the stator of the motor.

SP9.3 RTD Voting:

When this is enabled, the **DXT** will not post a trip until 2 RTD's have exceeded their programmed trip level. This prevents nuisance RTD tripping.

SP9.4 RTD Setup:

Each of the 12 RTDs is configured in the following manner. The first column is the RTD type, the second column is the RTD description, the third column is the alarm level, and the fourth column is the trip level. The first six RTDs have been pre-programmed with a description name for the STATOR, with two RTDs per phase.

RTDs #1 & #2 have been named STATOR PHASE A1 and A2 respectively. RTDs #3 & 4 are named STATOR PHASE B1 and B2; RTDs #5 & 6 are named STATOR PHASE C1 and C2.

If other description names are required, press the right arrow button from the RTD Type screen to go the RTD description screen. If no alarm or trip level is required these Setpoints can be turned off.

RTD Available Settings:

RTD TYPE:

- 120 OHM NICKEL (NI)
- 100 OHM NICKEL (NI)
- 10 OHM COPPER (CU)
- 100 OHM PLATINUM (PT)
- OFF

ALARM LEVEL: OFF or 0 - 240C (32-464F) Example: ### C = ### F, Increments of 1

RTD DESCRIPTION:

STATOR A1, STATOR A2, STATOR B1, STATOR B2, STATOR C1,
STATOR C2, FRONT BEARING, BACK BEARING, BEARING BOX,
AMBIENT, NONE

SP.9 RTD Option Configuration (Setpoint Page 9) - (Security Level 3) - Continued

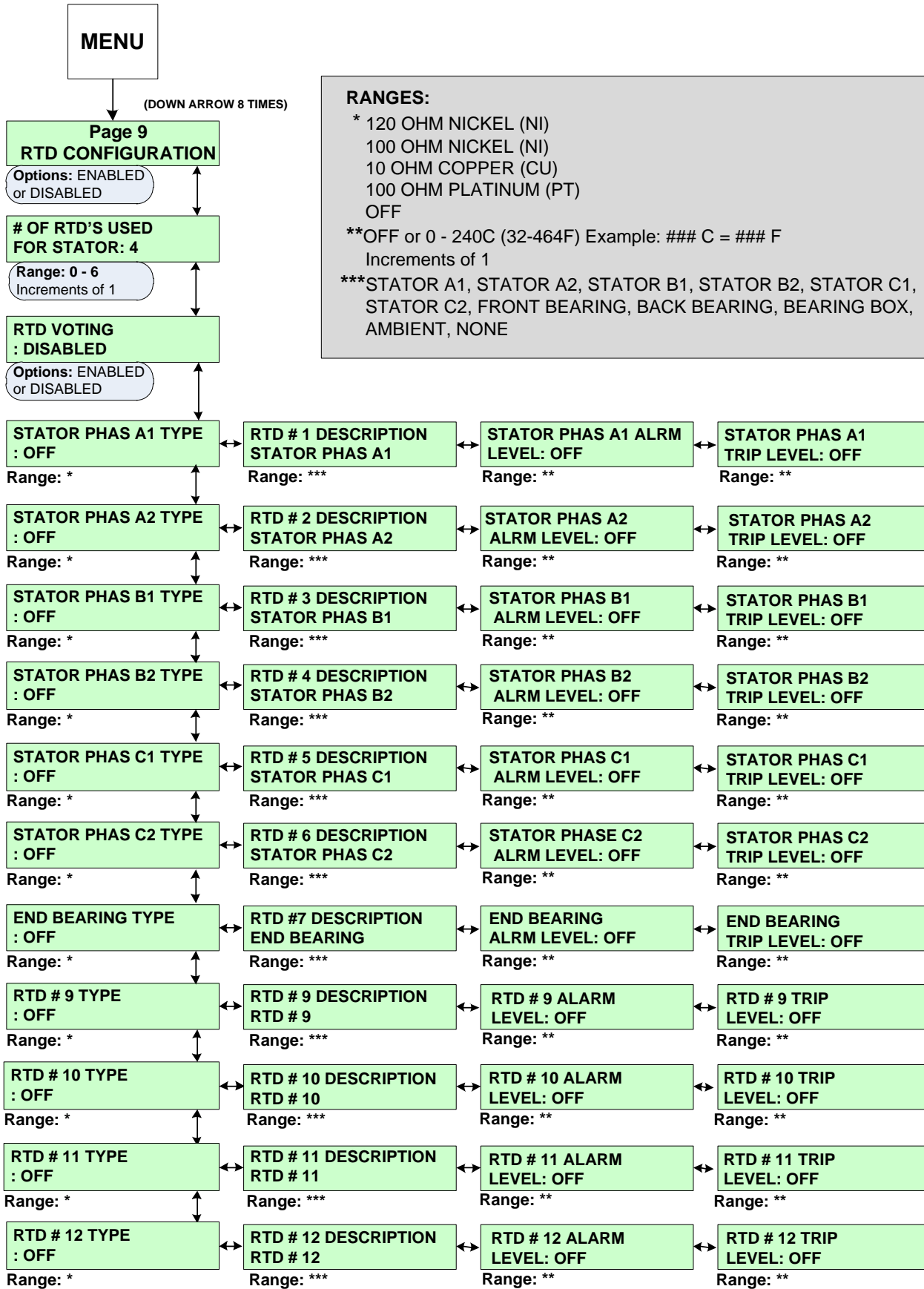

SP.10 Set Password (Setpoint Page 10) - (Security Level 3)

The DXT Series has three levels of user programmable setpoint screens. Level one setpoints do not require a password because the data contained in level one is basic nameplate data and starter control. Level two setpoint screens require a three-digit password to configure the protection schemes. Level three setpoint screens require a four-digit password to access the full range of protection and starter schemes.

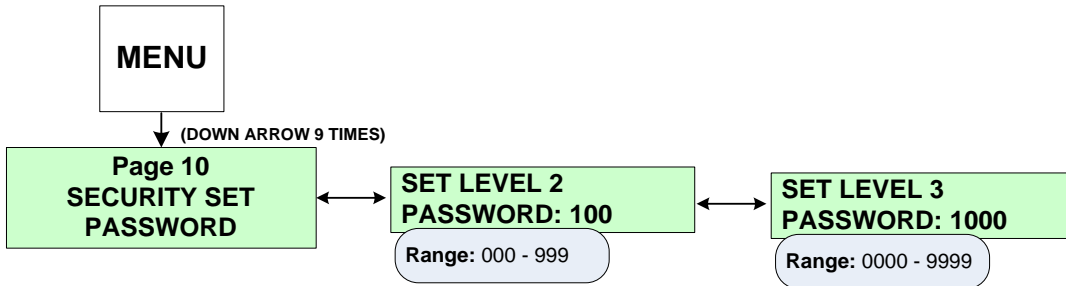

SP10.1 Set Level 2 Password: This level uses a 3-digit password. The default level 2 password is 100.

SP10.2 Set Level 3 Password: Level three uses a 4-digit password. The default level 3 password is 1000.

SP.11 Communications (Setpoint Page 11) - (Security Level 3)

SP11.1 Set Front Baud Rate: Configures the RS232 communications baud rate.

SP11.2 Set Modbus Baud Rate: Configures the Modbus communications baud rate

SP11.3 Modbus Address Number: Assigns a Modbus address to the unit.

SP11.4 Set Access Code: Assigns an access code to the Modbus addressing. This is typically not used

SP11.5 Set Link Baud Rate: Configures the RS422 communications baud rate between the keypad operator and the CPU board (For applications with remote keypad only).

SP11.6 Remote Start/Stop: Allows the RS485 Modbus communications to start and stop the motor. Contact factory for details.

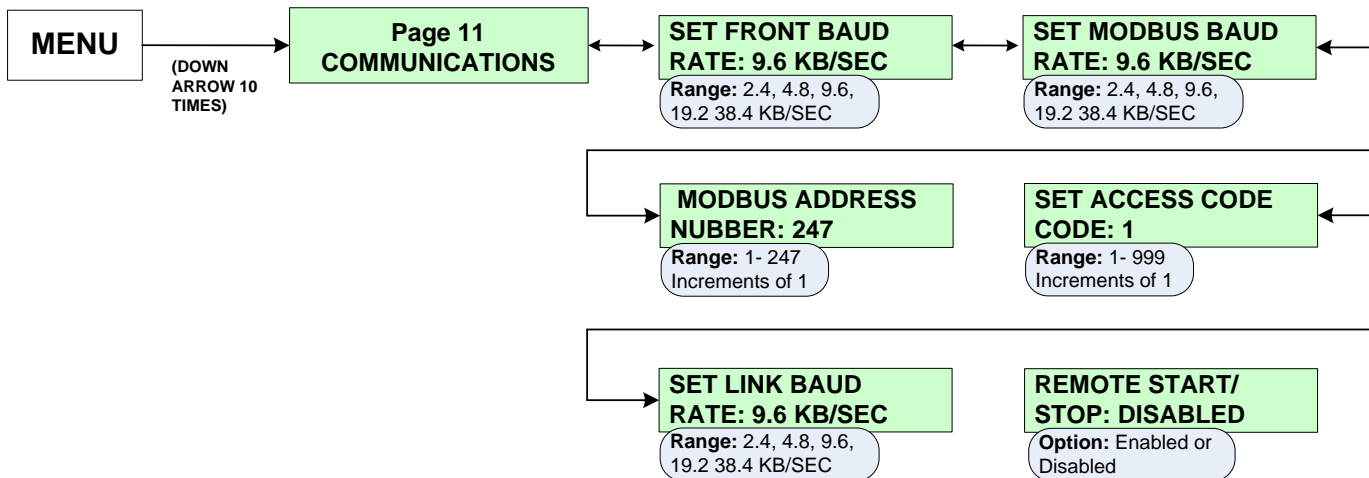

SP.12 System Setpoints (Setpoint Page 12) - (Security Level 3)

SP12.1 Default Display Screen: This Setpoint group allows the user to choose the default screen the DXT Series displays while the motor is running. Select the metering page number (1-4), then, select the metering screen number. The range varies depending on the selected page. To display a default screen, program the following two Setpoints:

- **Metering Data Page#:** Range is Page 1 - 4.
- **Metering Data Screen#:** If Page 1 is selected as the default page, then Screens 1- 10 are available. If Page 2 Screens 1-29 are available. If Page 3 is selected then Screens 1-6 are available. (See Metering Menu, MP.1, for screen number assignment.)

SP12.2 Alarms: Configures the RTD failure alarm (when RTD option is included) and the thermal register alarm.

- **RTD Failure Alarm:** If enabled, and an RTD shorts or open, an alarm occurs. (Only if RTD option is installed).
- **Thermal Register Alarm:** Sets a level in the thermal register to generate an alarm when the Thermal Register Capacity Used has exceeded this level.
- **Thermal Alarm Delay:** The amount of time that the Thermal Register Used must exceed the Setpoint before an alarm condition will occur.

SP12.3 Thermal Register Setup Information: This Setpoint group will configure the thermal register and indicate to the DXT Series which inputs to use when thermal modeling.

- **Cold Stall Time:** Enter the time from the motor manufacturer's specification sheet or use the time defined by the OL Class. This Setpoint is used to define the thermal capacity of the motor.
- **Hot Stall Time:** Enter the amount of time specified by the motor manufacturer or use half of the time defined by the OL Class.
- **Stopped Cool Down Time:** The time the motor needs to cool down after it has stopped. Use only the data provided by the motor manufacturer. This Setpoint is used to configure the cooling rate of the thermal register.
- **Running Cool Down Time:** The amount of time the motor needs to cool down while running. Use only the data provided by the motor manufacturer.
- **Relay Measured Cool Rates:** When the RTD option is supplied, the DXT Series can be configured to use the measured cooling rates from the RTDs instead of the programmed settings. This Setpoint should only be enabled when the RTD option is present.
- **Thermal Register Minimum:** Sets the value in the thermal register which represents a motor running at the nameplate current (with no overheating or negative sequence currents present).
- **Motor Design Ambient Temperature:** Use the data from the motor manufacturer's specifications. When RTD option is supplied, this Setpoint will be the base point for the RTD biasing of the Thermal Register.
- **Motor Design Run Temperature:** Use the data from the motor manufacturer's specifications. This Setpoint defines the operating temperature rise of the motor at full load amps or 100% load.
- **Motor Stator Max Temperature:** This represents the maximum temperature the stator insulation will withstand. The user may choose to use the temperature setting of the insulation class (selected in Setpoint Page 1) or enter a specific maximum temperature. This value should not exceed the stator's insulation temperature. This maximum temperature represents 100% thermal capacity.
- **U/B Input to Thermal Register:** Always enabled. It allows the DXT Series to use the line current imbalance information to bias the Thermal Register.
- **User Calculated K or Assign:** When the Setpoint is set to ON, the DXT Series will calculate the k constant factor for biasing the thermal register, or the user may choose to assign the k value.

- **SP12.4 Press Enter to CLR Thermal Register:** Allows the level three password user to clear the thermal register for emergency restarts.

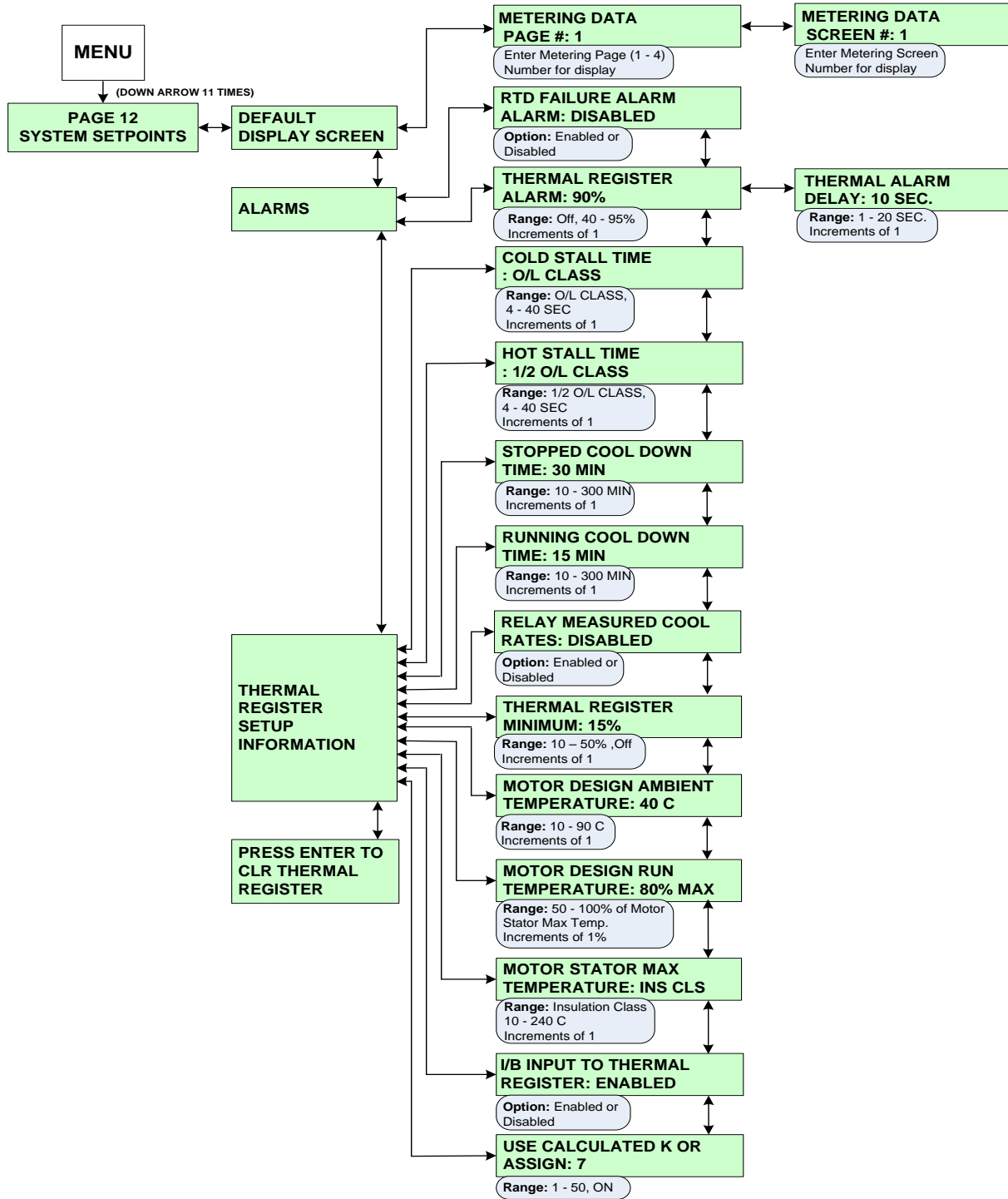

SP.13 Calibration & Service (Setpoint Page 13) - (Security Level 3)

Certain screens are displayed for user information only, such as Current date and time, Model number and Firmware revision number. *Setpoint changes in this page will only be accessible to factory personnel.*

SP13.1 Set Date and Time: Displays the date and time.

- **Enter Date (DDMMYYYY):** Allows the factory personnel to program the date for the DXT Series in the format shown.
- **Enter Time (HH:MM):** Allows the factory personnel to program the time for the DXT Series.

SP13.2 Model & Firmware #: Displays the model number and firmware revision in the DXT Series.

SP13.3 Press Enter to Access Factory Settings: Available to qualified personnel.

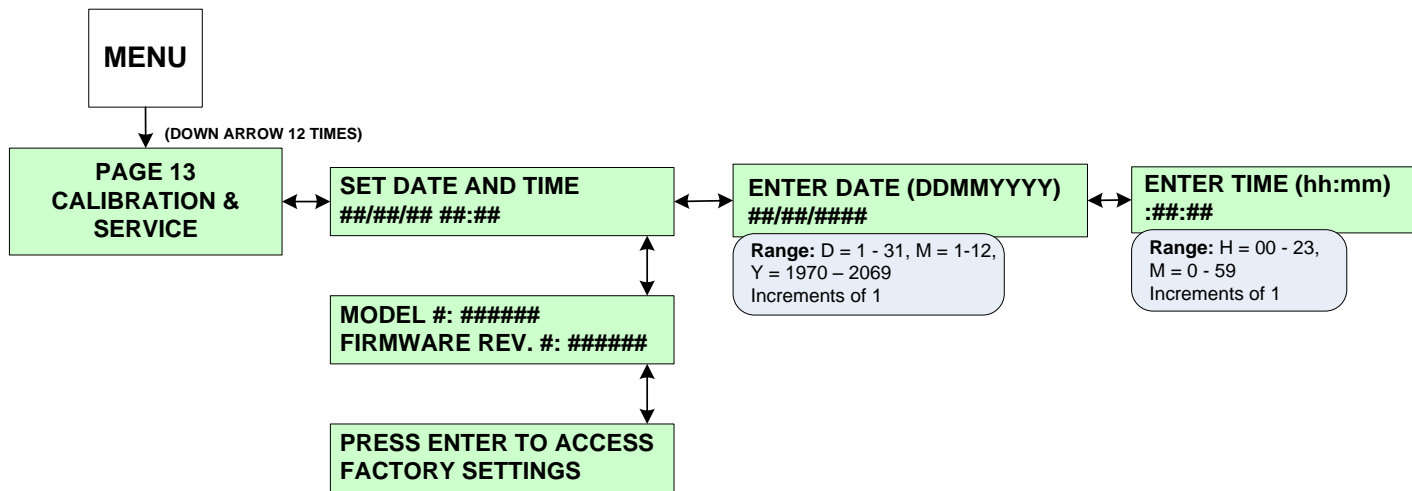

Chapter 6 - Metering Pages

The DXT Series offers performance metering which gives the user the ability to view information about the motor and the unit.

6.1 Metering Page List

The following charts list each Metering Page and the functions within that page. The applicable section of the manual is also referenced.

6.1.1 Metering Menu & Data (Metering Page 1)

Metering Page	Description of Display	Screen
PAGE 1 Metering Menu & Data	Phase A, B, C and Ground Fault (Option)	1
	Average current of the % of imbalance and the motor's RPM (Tach Option)	2
	Motor load as a percentage of motor FLA	3
	Line frequency and present phase sequence	4
	Percentage of remaining Thermal Register	5
	Thermal capacity required to start the motor	6
	Average time required to start	7
	Average current during start	8
	Measured I ² T required to start the motor	9
	Amount of time required to start the motor during the last successful start	10

6.1.2 Metering (Metering Page 2)

Metering Page	Description of Display	Screen
PAGE 2 Metering	Phase A, B, C currents and Power Factor	1
	Phase A, B, C currents and Ground Fault (Option)	2
	Displays KW and KVA	3
	Displays KVAR and Power Factor	4
	Displays Peak ON and KW Demand	5
	Displays Peak ON and KVA Demand	6
	Displays Peak ON and KVAR Demand	7
	Displays Peak ON and Amps Demand	8
	Clears Demand values	9
	Displays Megawatt hours used	10
	Press enter to clear statistics on MWH values	11

6.1.3 RTD Option Values (Metering Page 3)

Metering Page	Description of Display	Screen
PAGE 3 RTD Values	Hottest stator RTD (#1 - 6)	1
	Hottest non-stator RTD (#7 - 12)	2
	Temperature of start phase A1 in °C and °F	3
	Maximum temperature for RTD #1	4
	Same as Screens 3 - 4 for RTDs #2 - 12	5 - 26
	Clear the maximum temperature register (Level 3 password required)	27
	Measured running thermal stabilization time of motor (in minutes)	28
	Measured stopped cooling time (to ambient) of motor (in minutes)	29

6.1.4 Status (Metering Page 4)

Metering Page	Description of Display	Screen
PAGE 4 Status	Current status	1
	Amount of time remaining before an overload trip occurs	2
	Amount of time remaining from a thermal inhibit signal	3
	Coast down time remaining	4
	Amount of time remaining before a start command can be given	5
	Excessive number of starts per hour	6

6.1.5 Event Recorder (Metering Page 5)

Metering Page	Description of Display	Screen
PAGE 5 Event Recorder	Displays the event with date and time (Up to 60 events)	1
	Displays Phase A, B, C current values, Ground Fault (Option) at time of trip	1A
	Displays Vab, Vbc, Vca and Power Factor at time of trip	1B

6.1.6 Last Trip (Metering Page 6)

Metering Page	Description of Display	Screen
PAGE 6 Last Trip	Cause of last trip	1
	Measured phase current	2
	Measured voltage and power factor	3
	Imbalance percentage, the frequency and the kW	4
	Hottest stator RTD temperature	5
	Hottest non-stator RTD temperature	6

6.1.7 Statistics (Metering Page 7)

Metering Page	Description of Display	Screen
PAGE 7 Statistics	Total Megawatt Hours	1
	Accumulated Total Running Hours	2
	Clear the Total Running Hour Count	3
	Total Number of Trips / Number of Short Circuit Trips	4
	Number of Start and Run Overload Trips since the last statistical data clearing	5
	Number of frequency and Current Imbalance trips	6
	Number of Over Current Trips	7
	Stator and Non-Stator RTD Trips	8
	Ground Fault Hiset and Loset Trips	9
	Acceleration Time Trips	10
	Start Curve Trips	11
	I ² T Start Curve Trips	12
	Learned Start Curve Trips	13
	Shunt Trip Trips	14
	Phase Loss Trips	15
	Tach Acceleration Trips	16
	Undervoltage and Overvoltage Trips	17
	Power Factor Trips	18
	Phase Reversal Trips	19
	Low Control Voltage Trips	20
	Ext Inp #1 Trips	21
	Ext Inp #2 Trips	22
	Ext Inp #3 Trips	23
	Ext Inp #4 Trips	24
	Press ENTER to Clear Statistics	25

6.2 Metering Menu and Explanation

Push MENU key to toggle the screens between Setpoint Menu and Metering Menu and follow the arrow keys to get to different screens.

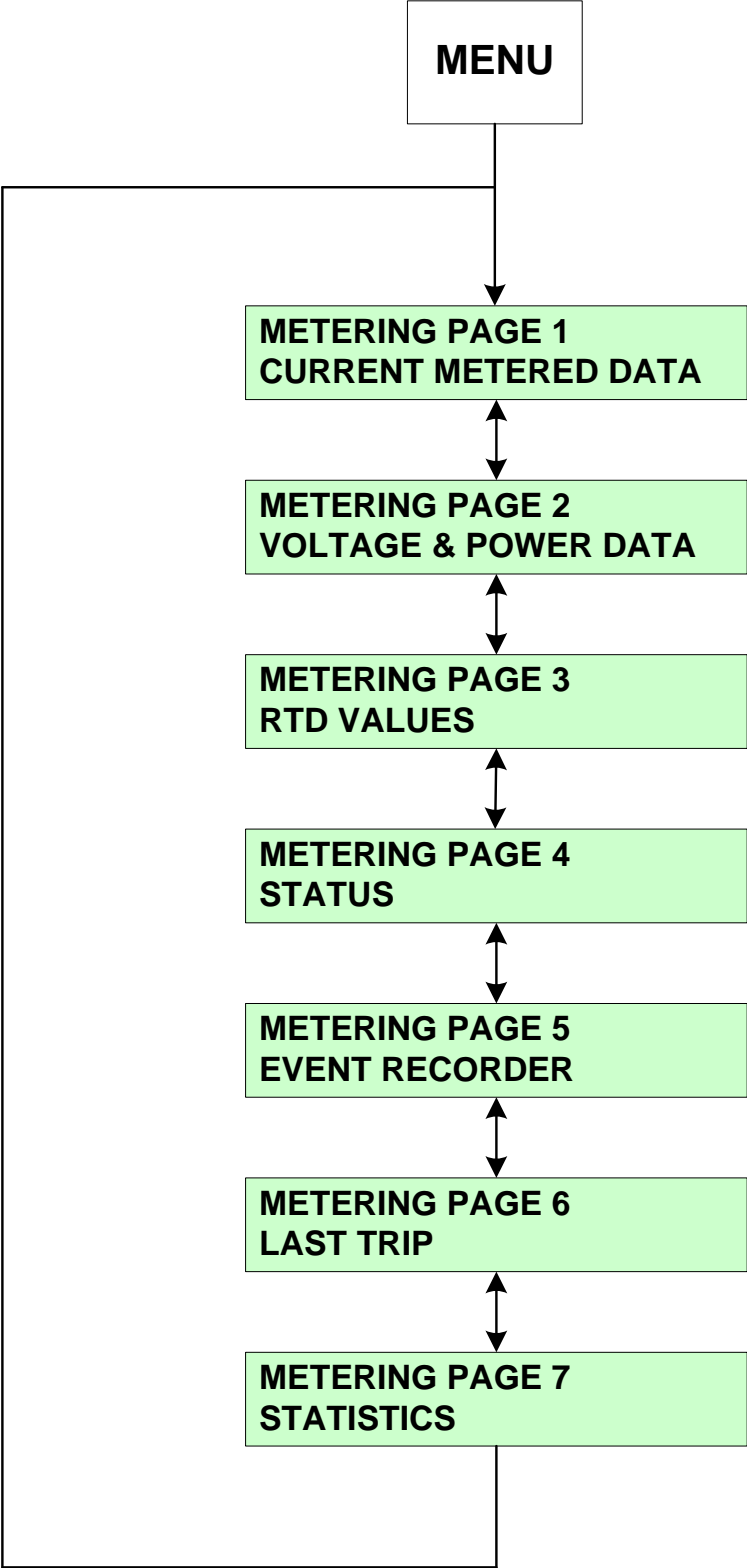

MP.1 Metering (Metering Page 1): Displays basic current metering data.

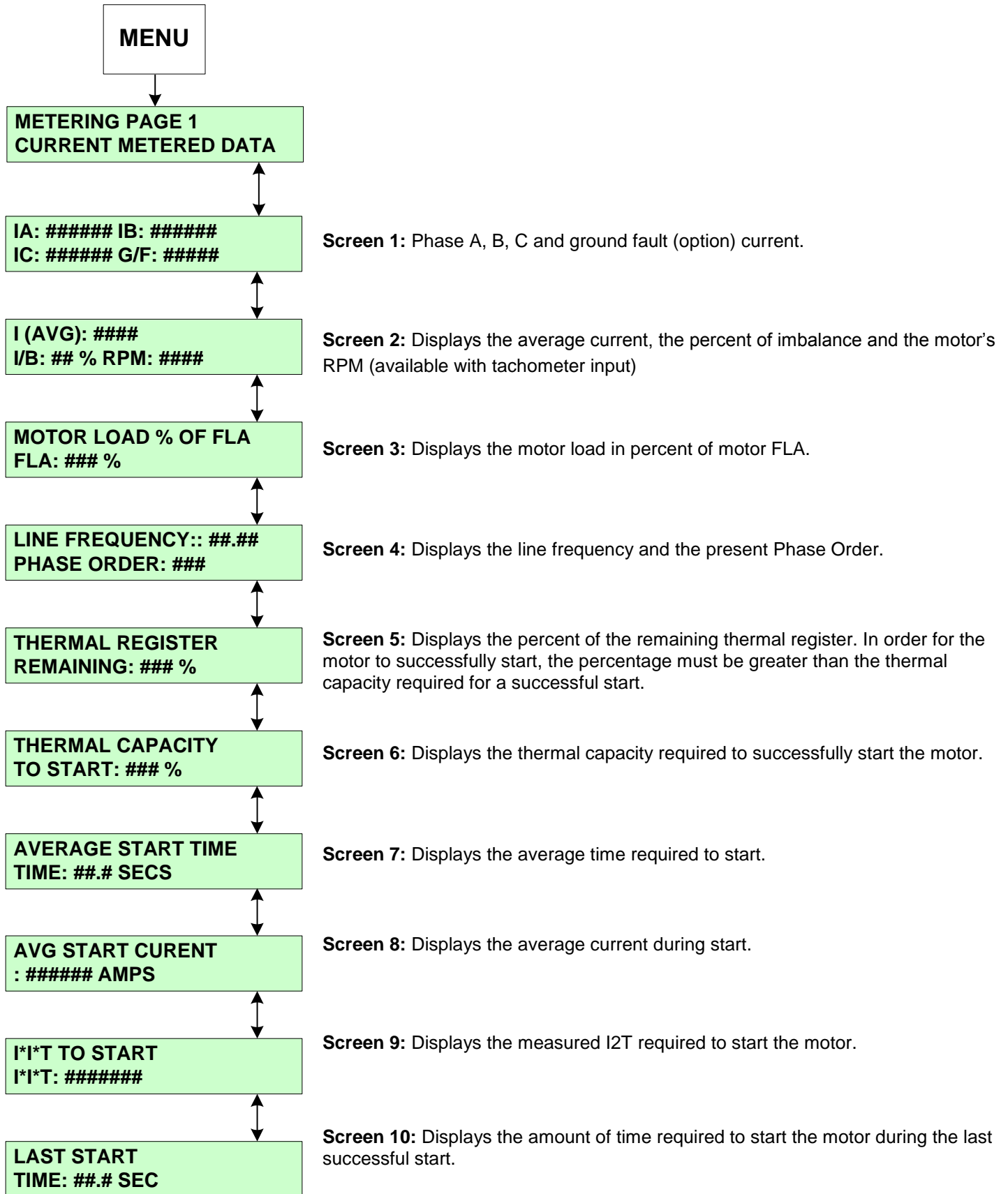

MP.2 Metering (Metering Page 2): Displays the DXT Series statistical voltage metering information

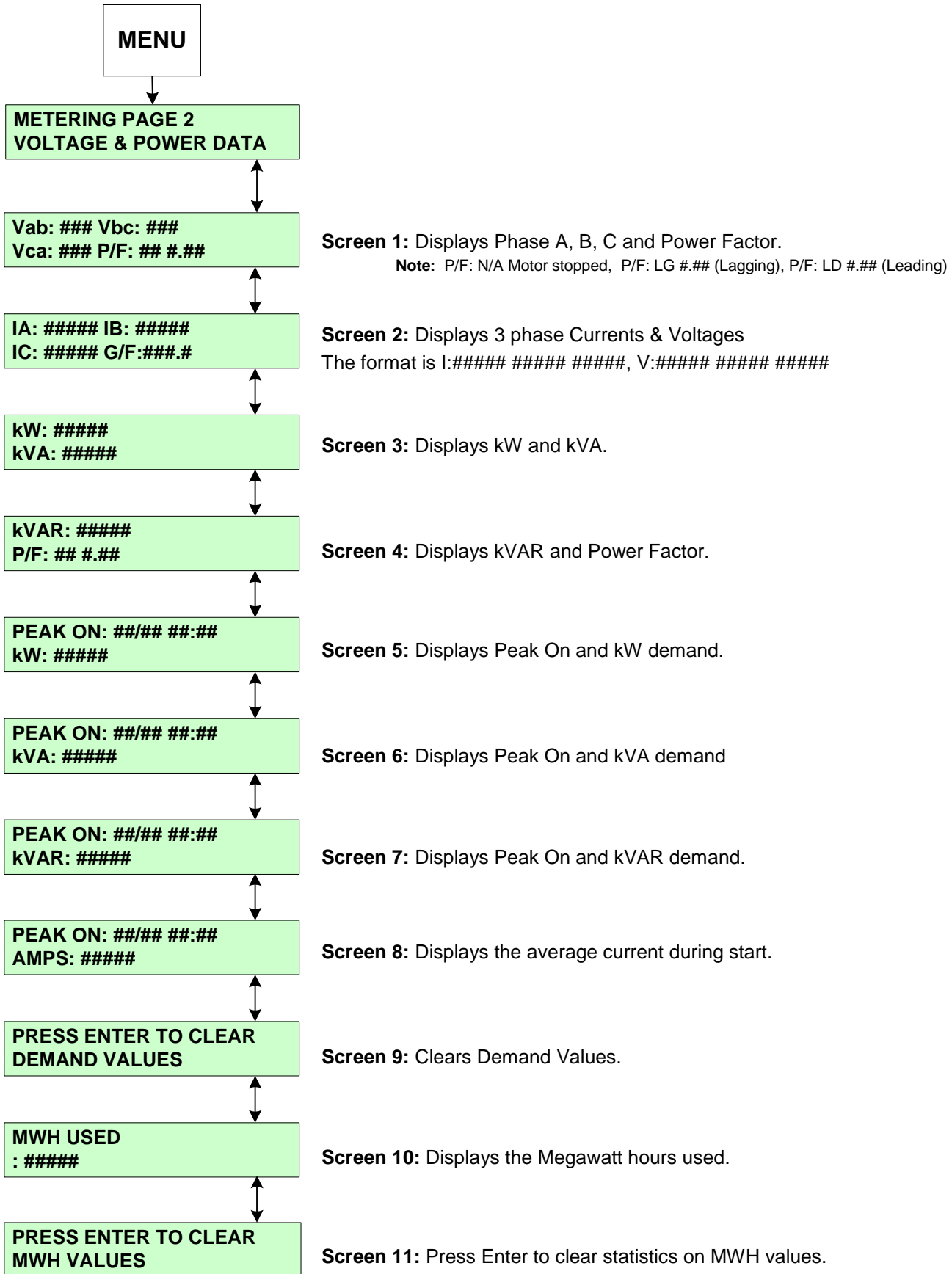

MP.3 Metering (Metering Page 3)

Displays the RTD information (When RTD option is installed)

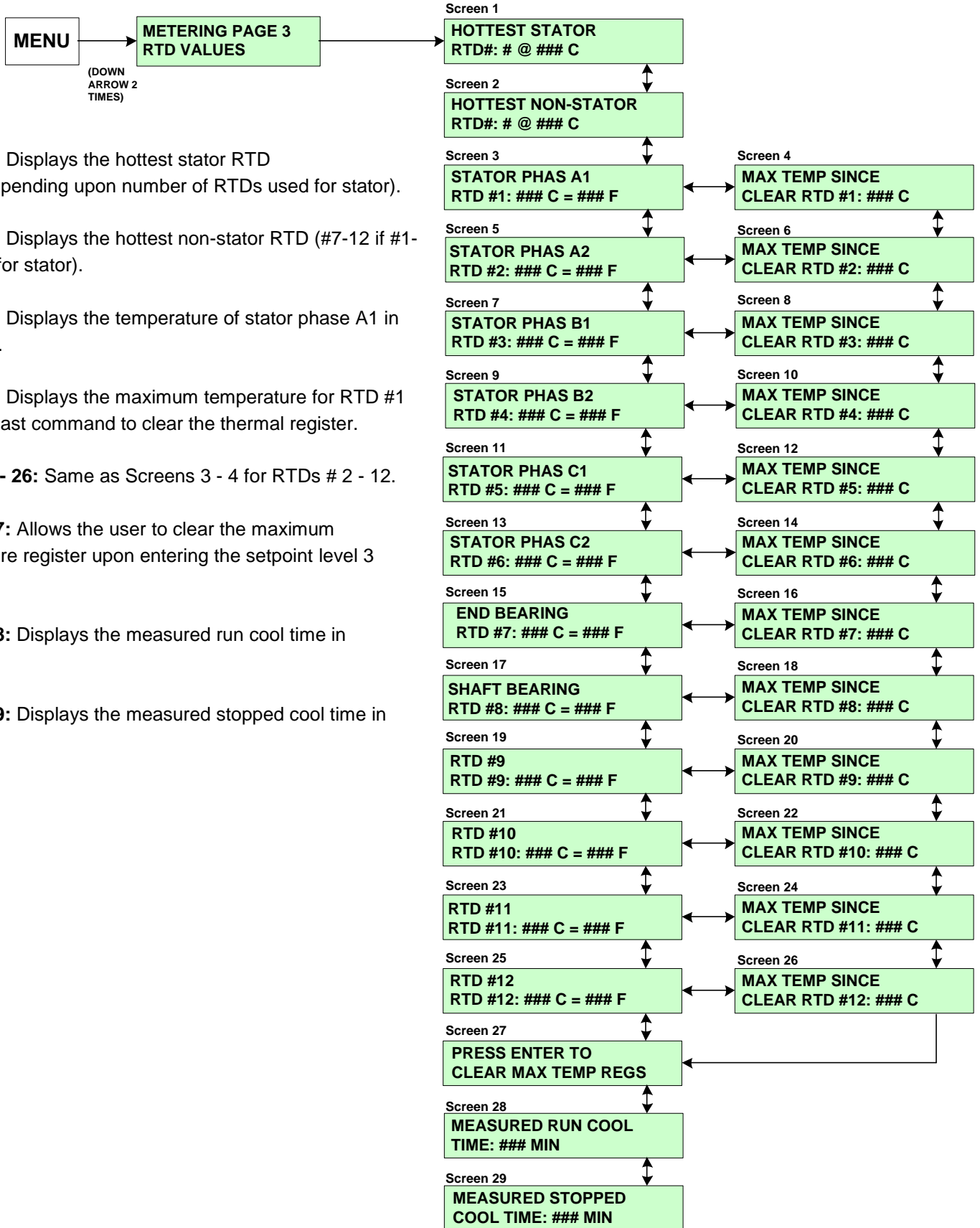

Screen 1: Displays the hottest stator RTD (#1 – 6 depending upon number of RTDs used for stator).

Screen 2: Displays the hottest non-stator RTD (#7-12 if #1-6 is used for stator).

Screen 3: Displays the temperature of stator phase A1 in °C and °F.

Screen 4: Displays the maximum temperature for RTD #1 since the last command to clear the thermal register.

Screen 5 - 26: Same as Screens 3 - 4 for RTDs # 2 - 12.

Screen 27: Allows the user to clear the maximum temperature register upon entering the setpoint level 3 password.

Screen 28: Displays the measured run cool time in minutes.

Screen 29: Displays the measured stopped cool time in minutes.

MP.4 Metering (Metering Page 4)

Displays the present status of the soft start

***Screen 1:** Displays the present state of the unit as follows:

Screen 2: Displays the amount of time remaining before an overload trip will occur.

Screen 3: Displays the amount of time remaining from a thermal inhibit. The inhibit time comes from the amount of thermal register remaining versus the amount of thermal capacity required to start.

Screen 4: Displays the coast down time remaining (Backspin time). The time remaining depends upon the user setting in Setpoint Page 8, Coast Down Time.

Screen 5: Displays the amount of time remaining before a start command can be given. The time remaining depends upon the setting in Setpoint page 5.

Screen 6: If the number of starts per hour has exceeded the setting in Setpoint page 8.

*** NOTE: Screen 1 CURRENT STATUS Screens include:**

MOTOR STOPPED
READY TO START

MOTOR STARTING
MULT. OF FLA

MOTOR RUNNING
AT ###.## X FLA

LAST TRIP CAUSE
NONE (or trip cause)

PROGRAMMING
SETPOINTS

MOTOR STATUS
UNKNOWN STATE ###

(Displays relay state upon error)

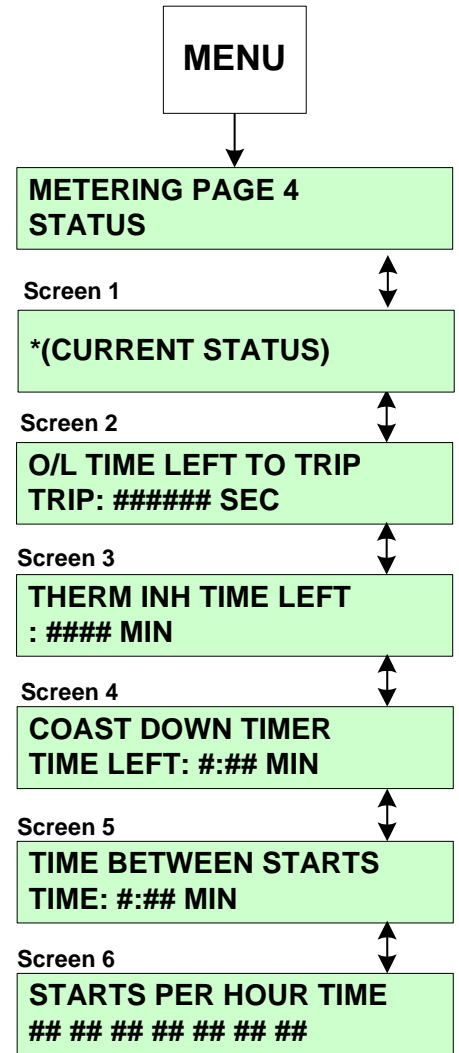

MP.5 Metering (Metering Page 5)

Displays the information in the Event Recorder.

Screen 1: Displays the event (i.e., Imbalance Trip) with the date and time it occurred.

Screen 1a: Displays the current at Phase A, B, C and the ground fault at the time of the trip. (**Note:** Ground fault option must be present)

Screen 1b: Displays the Vab, Vbc, Vca and power factor at the time of trip.

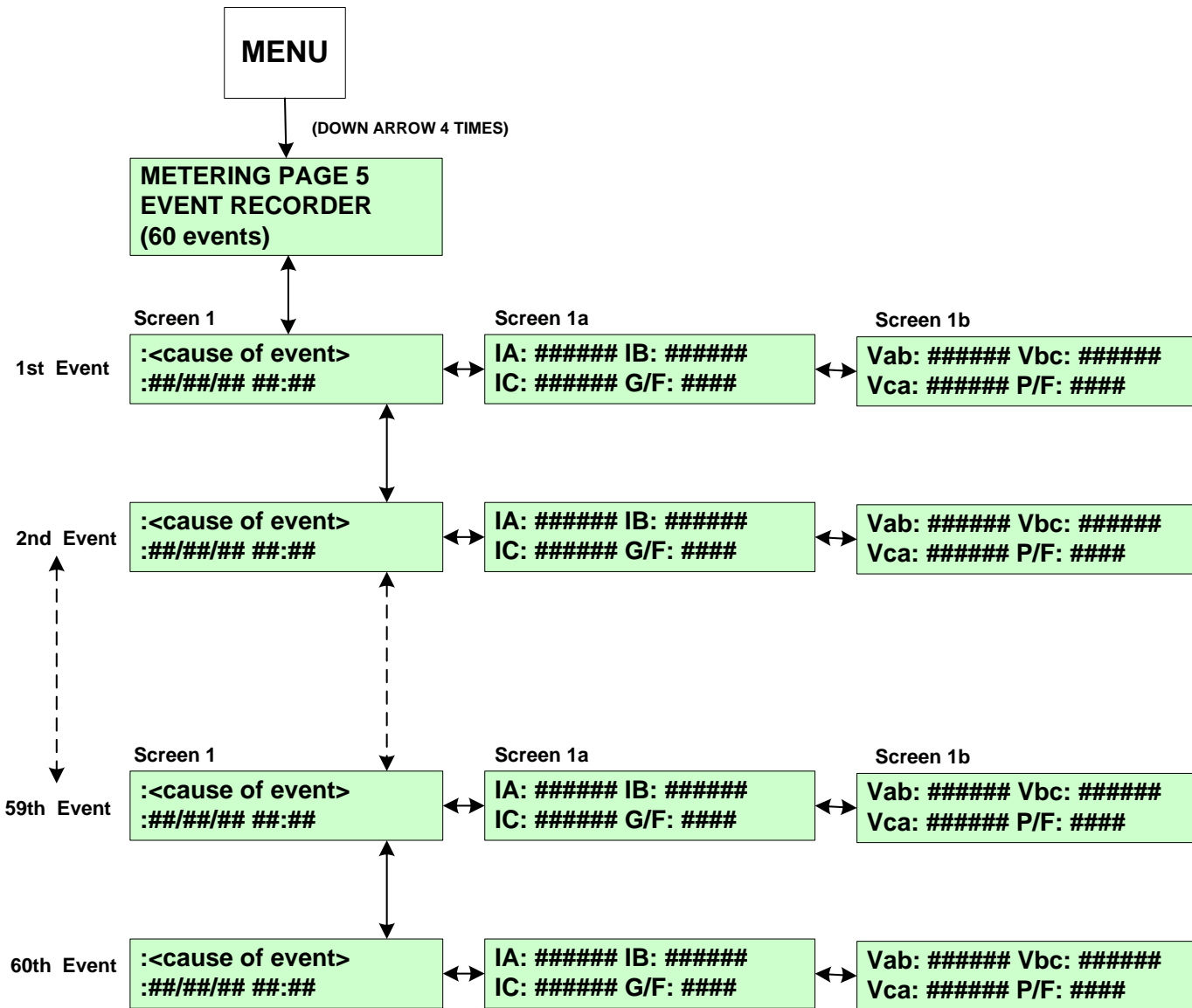

All events will be viewed from oldest event in buffer to most recent event.

MP.6 Metering (Metering Page 6)

Displays the last trip information

Screen 1: Displays the cause of the last trip.

Screen 2: Displays the measured phase current at the time of the trip.

Screen 3: Displays the Vab, Vbc, Vca and power factor at the time of trip.

Screen 4: Displays the imbalance percentage, the frequency and the kW at the time of the trip.

Screen 5: Displays the hottest stator RTD temperature (when RTD option present) at time of the trip.

Screen 6: Displays the hottest non-stator RTD temperature (when RTD option present) at the time of the trip.

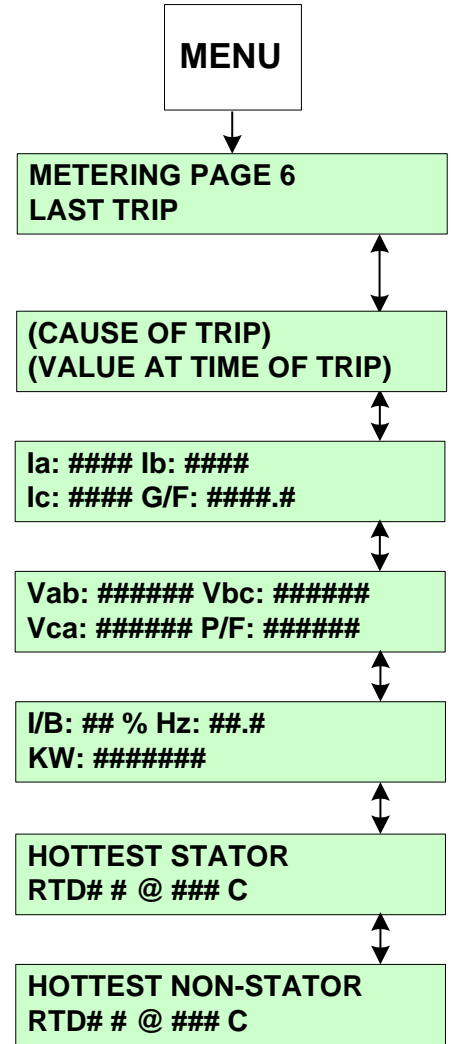

MP.7 Statistics (Metering Page 7)

Displays the statistical trip information

Screen 01: Displays the total of megawatt hours.

Screen 02: Displays the accumulated total running hours.

Screen 03: Clears the total running hour count.

Screen 04: Displays the total number of trips since the last clearing of the statistical data and the total number of short circuit trips.

Screen 05: Displays the number of start overload and run overload trips since the last clearing of the statistical data.

Screen 06: Displays the number of frequency trips and Imbalance trips.

Screen 07: Displays the number of overcurrent trips

Screen 08: Displays the number of Stator and non-Stator RTD Trips

Screen 09: Displays the number of Ground Fault Hi and Lo Set trips

Screen 10: Displays the number of acceleration time trips.

Screen 11: Displays the number of start under curve trips

Screen 12: Displays the number start over curve trips

Screen 13: Displays the number of I2T start curve trips

Screen 14: Displays the number of learned start curve trips.

Screen 15: Displays the number of fail shunt trips.

Screen 16: Displays the number of phase loss trips.

Screen 17: Displays the number of tachometer acceleration trips.

Screen 18: Displays the number of undervoltage and overvoltage trips.

Screen 19: Displays the number of power factor trips.

Screen 20: Displays the number of phase reversal trips.

Screen 21: Displays the number of low control voltage trips.

Screen 22: Displays the number of external input #1 trips.

Screen 23: Displays the number of external input #2 trips.

Screen 24: Displays the number of external input #3 trips.

Screen 25: Displays the number of external input #4 trips.

Screen 26: Requires a Security Level 2 password to clear the statistics.

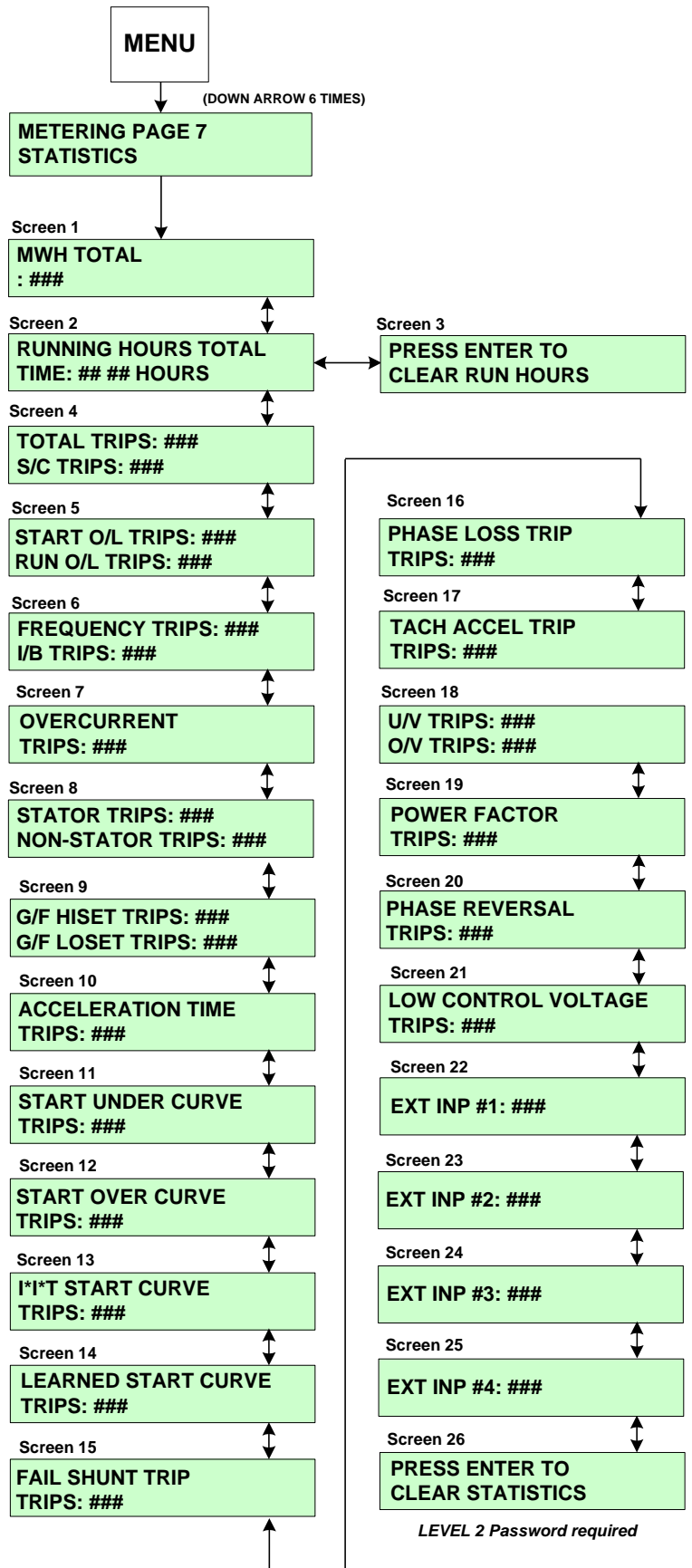

Chapter 7 - Maintenance and Troubleshooting

The DXT Series is designed to be a maintenance-free product. However, as with all electronic equipment, the unit should be checked periodically for build-up of dirt, moisture or industrial contaminants. These can cause arc-over, carbon tracking or prevent proper cooling of the SCR heat sinks. All bolts should be checked annually for proper tightness using an accurate torque wrench.

Note: If the unit is installed in a contaminated environment and forced air cooling is used, blower filters must be checked and cleaned regularly to insure proper air flow and cooling of the enclosure.

7.1 Failure Analysis

When a fault occurs, the LCD will display the fault error while the listed LED and AUX Relay will be lit. Please clear all faults before attempting to restart the unit.

Note: If the problem persists after the fault has been cleared, and all corrective actions have been taken, please contact the factory for assistance.

Problem	CPU LCD Display	LED	AUX Relay	Possible Cause	Solutions
Short Circuit Trip	SHORT CIRCUIT TRIP	Trip	AUX1	Short circuit or ground fault in motor/cabling	Locate and remove short or ground
				Phase Loss	Repair cause of phase loss
				Branch circuit protection not correctly sized	Verify correct sizing of branch circuit protection
				Faulty main circuit board	Remove power and replace main circuit board.
				Faulty SCRs	Remove power and test SCR(s). Refer to Section 7.1.1 for the SCR testing procedure
Single Phase Trip	SINGLE PHASE TRIP (Check LCD display for possible fault indicators)	Trip	AUX1	Single phase incoming power	Correct problem with incoming power
				Faulty SCRs	Remove power and test SCR(s). Refer to Section 7.1.1 for the SCR testing procedure
				Environment Temperature over 122° F (ambient temperature for chassis units) or over 104°F (ambient temperature for enclosed version)	Place unit in environment temperature less than 122°F for panel version or less than 104°F for enclosed version.
				Bypass failed to close	Check bypass contactor and wiring. The "At Speed" delay is incorrectly programmed. Reprogram back to factory default value.

7.1 Failure Analysis - Continued

Problem	CPU LCD Display	LED	AUX Relay	Possible Cause	Solutions
Phase Loss	PHASE LOSS	Trip	AUX1	Loss of 1 or more phases of power from utility or generated power.	Check power source.
				Blown power fuses	Check for short circuits.
Overload	OVERLOAD TRIP	Trip	AUX1	Improper programming	Check motor nameplate versus programmed parameters.
				Possible load damage or jammed load	Check motor currents.
Stall prevention	ACCEL TIME TRIP	Trip	AUX1	Improper setting for motor load condition	Verify current limit setting.
				Damaged load	Check for load failure.
Under Voltage Trip	UNDER VOLTAGE TRIP	Trip	AUX1	Improper programming	Check Setpoint settings.
				Wrong position of disconnect or breaker	Check disconnect or open breaker
				Feed Transformer too small	Reduce current limit setting, saturation or sagging power supply transformer
				Overloaded motor	Check load
Self-test Failure	SELF-TEST FAILURE	Trip	AUX1	Failed CPU or Main Firing Board	Contact factory
				Vibration	Check internal wiring connections
Line Frequency Trip	OVER OR UNDER FREQUENCY TRIP	Trip	AUX1	Generator Power Problem or grid change	Troubleshoot and repair generator
					Contact utility company
					Main board failure
					Three phase power removed from Main
Any Ground Fault Trip	GROUND FAULT HI-SET OR LO-SET	Trip	AUX1	Improper programming	Check Setpoint settings
				Any wire going to ground (I.e. stator ground, motor ground, soft start ground)	Check with megger or Hi-pot motor leads and motor
				High vibration or loose connections	Check internal connections
Short Circuit Trip	Check for fault indication	Trip	AUX1	 WARNING This is a serious fault condition. Ensure that the fault condition is cleared on the load side before attempting to restart the motor.	
				Load shorted	Remove power and repair.
				Faulty main circuit board	Replace the main circuit board

7.1 Failure Analysis - Continued

Problem	CPU LCD Display	LED	AUX Relay	Possible Cause	Solutions
<i>Control circuit fuses blow after control power is applied.</i>	None	None	None	Short in Control Circuit	Remove Power, locate and remove the short.
				Wrong Control Voltage	Apply the correct voltage to the control circuit.
<i>Motor will not start</i>	Any fault indication message	Trip	AUX1	No Control Voltage applied to Control Board	Apply control voltage to control board.
				Control Power Transformer failure or CPT Fuse failure	Remove power and replace the power transformer or the CPT fuse
				Start Circuit Wired Incorrectly	Remove power and correct the start circuit wiring.
				No Start Command	Apply the start command.
				No 3 Phase Line Voltage	Apply 3 phase line voltage to the unit.
				Shorted SCR in Starter	Remove power and Test SCR(s). Refer to Sec. 7.1.1 for the testing procedure.
				Faulty Control Logic	Remove power and repair the Control Logic.
				Failure of Main Circuit Board	Replace the Main Circuit Board.
<i>Motor vibrates / Motor growls while starting or extremely unbalanced motor currents run mode</i>	IMBALANCE TRIP	Trip	AUX1	Faulty Motor	Check the Motor and the Motor connections.
				Faulty SCR(s)	Remove Power and perform the SCR device checks.
				Faulty Gate / Cathode on SCR(s)	Remove Power and Test SCR(s). Refer to Sec. 7.1.1 for the testing procedure.
				Faulty Main Circuit Board.	Replace the Main Circuit Board.
	IMBALANCE ALARM	Alarm	AUX2	Faulty Motor / Wiring	Troubleshoot and repair / replace wiring.
				Faulty Main Circuit Board	Replace the Main Circuit Board.

7.2 SCR Testing Procedure



Warning!

Failure to remove both line and control power before starting or this procedure may cause personal injury or death.

Remove both line power and control power from the unit and lock out. Disconnect any two motor load leads and any two line leads. Disconnect the SCR connections to main control board J1, J2 and J3. Refer to section 2.9b for the main control board layout. Note the type of color coding of the wires connected to J1, J2 and J3. Two possible configurations are used. Both configurations have 4 wires going to each plug. The first configuration consists of 4 wires color coded black, yellow, grey and white. The second configuration consists of 4 wires color coded red, white, red, white.

The testing procedure for SCRs is comprised of two separate tests. The first one tests the anode to cathode integrity of the SCR by performing the following ohm checks:

+ Lead	- Lead	Good	Consult factory
L1 Lug	T1 Lug	Greater than 10K ohm	Less than 10K ohm
L2 Lug	T2 Lug	Greater than 10K ohm	Less than 10K ohm
L3 Lug	T3 Lug	Greater than 10K ohm	Less than 10K ohm

The second tests the gate to cathode integrity of the SCR. The chart below indicates good versus bad readings.

For wire that is color coded black, yellow, gray and white:			
+ Lead	- Lead	Good	Bad
Black	Yellow	Between 5 and 90 ohms	Less than 5, or greater than 90 ohms
Grey	White	Between 5 and 90 ohms	Less than 5, or greater than 90 ohms
For wire that is color coded red, white, red and white:			
Red	White	Between 5 and 90 ohms	Less than 5, or greater than 90 ohms
Red	White	Between 5 and 90 ohms	Less than 5, or greater than 90 ohms

Note: If any of the above readings are out of specifications, replace the faulty SCR.

Note: The best way to test an SCR is with an SCR Tester and to look for leakage current less than the manufacturer specified values.

7.3 Replacing SCR Devices

Two types of SCRs are used in the DXT Series depending on the horsepower/amperage rating of the unit. Isolated SCRs are used in smaller units and “hockey puck” type SCRs are used in larger units.

7.3.1 Changing an Isolated SCR

- Remove both line and control power from unit, tag and lock out.



WARNING!

Failure to remove both line and control power before starting this procedure may cause personal injury or death.

- Label the location of wires connected to the SCR.
- Remove the mounting screws, lugs and associated wiring from the existing SCR.
- Make sure the surface to which the power module mounts is clean and free from dirt, nicks and scratches.
- Apply thermal grease uniformly along the mounting surface of the SCR. Spread the grease thinly (3 mil thick) to completely cover the base of the power module and minimize air pockets. The grease must be free of contamination.
- Replace the screws and tighten down firmly. All SCR mounting screws should be 44lb/in. Units with a maximum amperage rating of up to 48A, should use 26 lbs/in for busbar and power lugs. Units with a maximum amperage of 60A - 120A should use 44 lbs/in for busbar and power lugs.
- Reconnect all busbars, lugs and wires. Check to make sure the gate and cathode are wired correctly. Use the following chart to verify the wiring of J1, J2 and J3:
- After verifying that all wiring is correctly connected, test the SCR.

Main Circuit Board Pin #	Destination
Pin 1	Load Gate
Pin 2	Load cathode (Output Load Lug)
Pin 5	Line Gate
Pin 6	Line Cathode

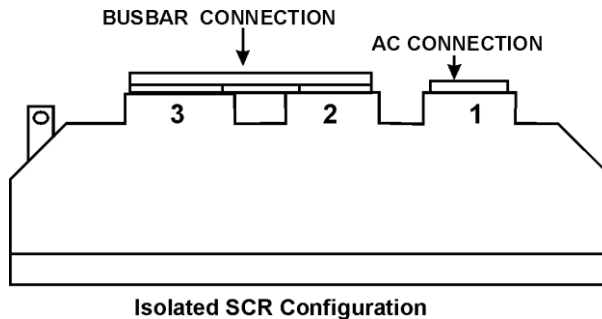

7.3.2 Changing a Hockey Puck Type SCR

- Remove both line and control power from unit, tag and lock out.



Warning!

Failure to remove both line and control power before starting this procedure may cause personal injury or death.

A PEG style clamp is used for a puck style SCR and it is recommend to replace the entire SCR/Heat Sink assembly when necessary. If however a single SCR must be field replaced, please contact the factory for assistance.

- Label the location of the wires connected to the SCR and/or Heat Sink.
- Remove any lugs, snubbers, printed circuit boards and associated wiring that may get in the way of reaching the assembly or faulty SCR. Document the location and wiring of all parts before removing them to facilitate the reinstallation of the devices later.
- Then remove the PEG clamps holding the SCR stack together. Remove the top heatsink. Use extreme caution when handling the heat sink so it does not become dented or damaged.
- Remove the faulty SCR device, noting the direction in which the SCR is oriented. The new SCR puck **must be** inserted in the same direction.
- Make sure the SCR mounting surface, is clean and free from dirt, nicks, and scratches. Do not sand or scrape the SCR mounting surface. If necessary, super fine Scotch Brite pads can be used to clean the heatsink before installing the new SCR.
- Apply a thin (3 mil thick) layer of thermal grease uniformly along both sides of the SCR. Spread the grease to cover the entire surface of both sides of the SCR in a manner that minimizes air pockets. The grease must be free of contamination.
- Locate the centering pin in the bottom and top of the heatsink and center it in the SCR hole (making sure that the SCR is oriented in the same direction as the SCR that was removed). Locate the centering pin in the top heatsink and center it in the SCR hole. **Caution: If center pin is not placed correctly it will damage the SCR and the heat sink.** Hand tighten the PEGs evenly per factory specs. Once proper force is reached make sure that the SCR pucks are securely held between the heatsinks and aligned evenly.
- Replace any lugs, MOVs, snubbers, power straps, printed circuit boards and associated wiring that were removed in step 4. Use the following chart to verify wiring of J5, J6 and J7:

Main Circuit Board Pin #	Destination
Pin 1	Load Gate
Pin 2	Load cathode (Output Load Lug)
Pin 5	Line Gate
Pin 6	Line Cathode

- After verifying that all wiring is correctly connected, test the SCR and then test the unit.

7.4 Replacing the Main Control Board

The printed circuit board is not intended to be field repaired. If the board is faulty, the entire board should be replaced using the following procedure:

- Make sure to observe proper Anti-Static control measures when handling printed circuit boards.
- Remove three phase power and control power from the unit and lock out.
- Remove plugs and tag plugs with connector numbers.
- Remove control wires from terminals and tag wires with terminal numbers.
- Note the settings of all jumpers.
- Remove the mounting screws.
- Remove the old printed circuit board.
- Mount the new printed circuit board.
- Install the mounting screws.
- Set the jumpers to the same position as on the old board.
- Install the control wires onto correct terminals per tag sequence.
- Install the plugs.
- Apply power to the unit and program all parameters to values in old board.
- Test

7.5 Interconnect Drawing

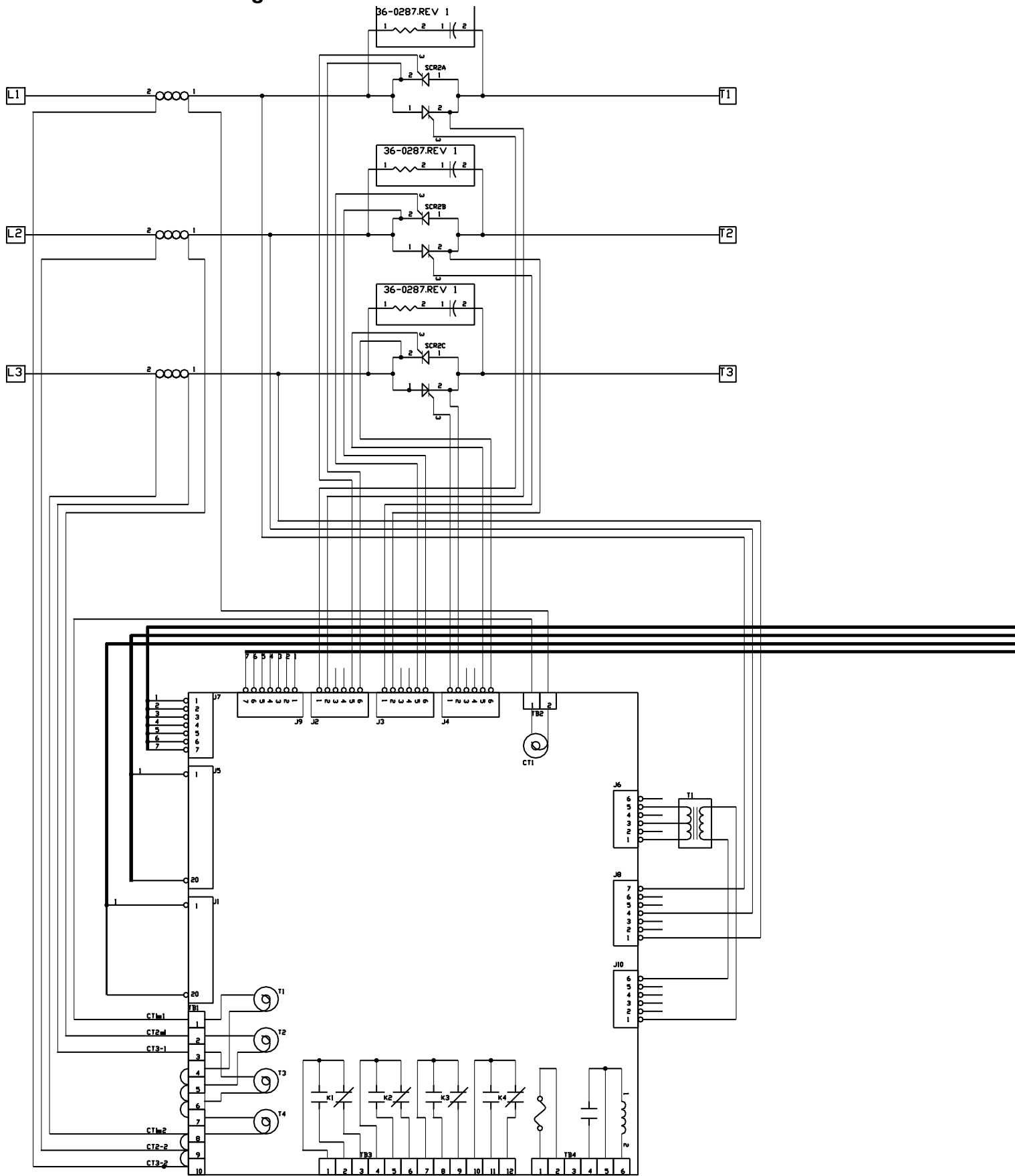

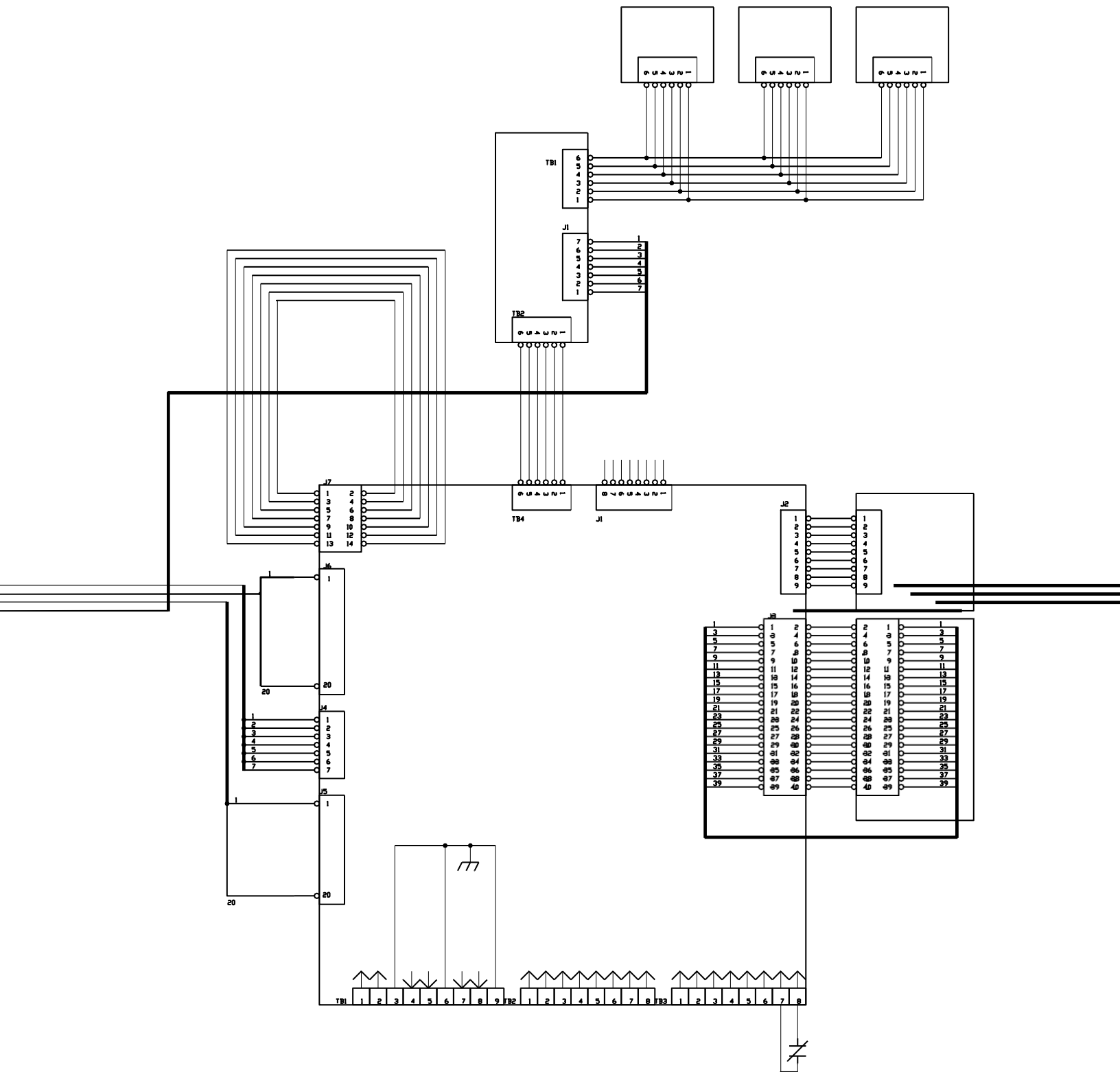



MOTORTRONICS™

Solid State AC Motor Control

DXT

Series

Advanced Digital Soft Starter

Phasetronics Inc. dba Motortronics
1600 Sunshine Drive
Clearwater, Florida 33765
USA

Tel: +1 727.573.1819 or 888.767.7792
Fax: +1 727.573.1803 or 800.548.4104

www.motortronics.com